

Hypertherm®

REXPO
CUTTING & BLASTING SOLUTIONS

HyPrecision 15/30/50™

Waterjet Pump



Operator Manual

808240 | Revision 1 | English

HyPrecision and Hypertherm are trademarks of Hypertherm Inc. and may be registered in the United States and other countries. All other trademarks are the property of their respective holders.

© 2015 Hypertherm Inc.

HyPrecision 15/30/50

Operator Manual

808240
Revision 1

English
Original Instructions

July 2015

Hypertherm Inc.
Hanover, NH 03755 USA
www.hypertherm.com

North America

USA and Canada

Technical service

800-643-9878 Toll-free

TechnicalService-Hanover@Hypertherm.com

Customer service

800-737-2978 Toll-free

Return materials

866-643-7711 Toll-free

Asia Pacific

TechnicalService-Asia@Hypertherm.com

Singapore

65 6841 2489

65 6841 2490 Fax

China

86-21-60740003

86-21- 60740393 Fax

Japan

+81-6-6225-1183

+81-6-6225-1184 Fax

India

+91-11-40521201/ 2/ 3/

+91 7838908053 Mobile

+91-11 40521204 Fax

Korea

+82-51-747-0358

+82-51-701-0358 Fax

Australia and New Zealand

+61 (0) 7 3103 1695

+61 (0) 4 3760 6995 Mobile

+61 (0) 7 3219 9012 Fax

Europe, Middle East, and Africa

Technical service

00 800 4973 7843 Toll-free

+31(0) 165 596900

+31(0) 165 596906 Fax

TechnicalService-HyperthermEurope@Hypertherm.com

Customer service

00 800 3324 9737 Toll-free

+31 (0) 165 526156

00 800 4973 7329 Toll-free fax

+31 (0) 165 596948 Fax

Return materials

+31 (0) 165 596936

+31 (0) 165 596906 Fax

South America

TechnicalService-SA@Hypertherm.com

Brazil

55 11 2409 2636

55 11 2408 0462 Fax

Argentina

+54 (11) 5199-4668

Peru

+51 (1) 718-5090

Chile

+56 (2) 495-7369

Venezuela

+58 (212) 335-7522

México

52 55 5681 8109

52 55 5681 7978

52 55 5683 2127 Fax

Pump information 9

Warranty SC-11

Product stewardship SC-13

National and local safety regulations SC-13

Certification test marks SC-13

 Declaration of conformity SC-13

Differences in national standards SC-15

Higher-level systems SC-15

Environmental stewardship SC-17

Proper disposal of Hypertherm products SC-17

Proper handling and safe use of chemicals SC-17

Particle emission and wastewater quality SC-17

Safety SC-19

User qualification and training SC-19

Emergency medical information and treatment SC-20

Symbols and marks SC-21

Information and hazard symbols SC-21

Symbols and marks found on the data plate and the pump SC-22

1 Terminology 25

2 Product description 29

Pump exterior 30

Major systems 32

 Hydraulic system 32

 Low-pressure water system 37

 High-pressure water system 39

 Electrical system 40

3 Options 43

Voltage 43

Contents

Air-cooled external heat exchanger43
Water-modulating valve43

4 Operation 45

Safety45
Overview46
Inspect the pump before operation48
Turn on the pump48
 Turn on the pump locally48
 Turn on the pump remotely49
Operate the pump50
 Operator interface50
 Operate the pump remotely58
Stop the pump59
 Emergency stop59
 Routine stop during operation59
 Routine stop at the end of the day59

5 Preventive maintenance 61

Benefits of preventive maintenance61
Safety62
Tips63
Preventive maintenance schedule64
Tools66
 Complete list of preventive maintenance kits, parts, tools, and materials67
 Every shift68
 Every 40 hours76
 Every 500 hours78
 Every 1,000 hours85
 Every 1,500 hours92
 Every 2,000 hours93
 Every 3,000 hours94
 Every 6,000 hours100
 Every 12,000 hours101
Service the intensifier102
 Disassemble the intensifier104
 Assemble the intensifier111
Service the bleed-down valve128
 Disassemble the bleed-down valve131
 Assemble the bleed-down valve133
 Install the bleed-down valve135

Start the pump after preventive maintenance 137

Preventive maintenance interval checklist 139

 Preventive maintenance records 144

6 Parts lists 147

7 Troubleshooting 153

 Safety 153

 Tips 153

 Alarm screens 154

 The pump will not start 154

 Intensifier 155

 Stroking problems 155

 Leaks 159

 Short seal life 160

 Hydraulic fluid 161

 Low pressure 161

 High temperature 161

 Low water pressure 163

 From the intensifier 163

 To the intensifier 163

 Motor fault 164

8 Pump specifications 165

 HyPrecision 15 166

 HyPrecision 30 167

 HyPrecision 50 168

 All models 169

 Hydraulic fluid 169

 Operating conditions 169

 Cooling requirements 169

 Utility fittings 170

 Torque values 171

 Fasteners 171

 Fittings 173

9 Installation 177

 Safety 177

 Buyer obligations 178

 Seller obligations 179

 Requirements 179

Contents

Location 179

Temperature 179

Electrical power 180

Air 180

Water 181

Receive and unpack the pump 183

Install the external heat exchanger 184

Make the connections for remote operation 184

Make the connections to the utility panel 186

Add hydraulic fluid 187

Connect the electrical power 188

Do the first startup 189

Recycling and end of product life 193

Model

Serial number

The serial number is on the data plate, which is found above the connection panel on the back of the pump.

**System
schematic
drawing number**

The system schematic drawing number is found on the data plate and inside the electrical enclosure door on a green label.

Purchase date

Distributor

Installation date

Installed by

Notes

Pump information

Waterjet product warranty coverage

Product	Parts coverage
HyPrecision pumps	27 months from the ship date, or 24 months from the date of proven installation, or 4,000 hours, whichever occurs first
Bulk abrasive hoppers	15 months from the ship date or 12 months from the date of proven installation, whichever occurs first
Abrasive regulators (abrasive metering devices)	15 months from the ship date or 12 months from the date of proven installation, whichever occurs first
On/off valve air actuators	15 months from the ship date or 12 months from the date of proven installation, whichever occurs first
Diamond orifices	600 hours of use with the use of a thimble filter and compliance with Hypertherm's water quality requirements

Consumable parts are not covered by this warranty. Consumable parts include, but are not limited to, high-pressure water seals, check valves, cylinders, bleed-down valves, low-pressure seals, high-pressure tubing, and low- and high-pressure water filters.

Hypertherm maintains a global Regulatory Management System to ensure that products comply with regulatory and environmental requirements.

National and local safety regulations

National and local safety regulations shall take precedence over instructions supplied with the product. The product shall be imported, installed, operated and disposed of in accordance with national and local regulations applicable to the installed site.

Certification test marks

Certified products are identified by one or more certification test marks from accredited testing laboratories. The certification test marks are found on or near the data plate.

Each certification test mark means that the product and its safety-critical parts conform to the relevant national safety standards as reviewed and determined by that testing laboratory. Hypertherm puts a certification test mark on its products only after that product is manufactured with safety-critical parts that have been authorized by the accredited testing laboratory.

Once the product has left the Hypertherm factory, the certification test marks are invalidated if any of these events occur:

- The product is modified in a manner that creates a hazard or nonconformance with the applicable standards.
- Safety-critical parts are replaced with unauthorized spare parts.
- Assembly is unauthorized.
- An accessory that uses or generates a hazardous voltage is added.
- There is tampering with a safety circuit or other feature that is designed into the product as part of the certification, or otherwise.

A Conformité Européene (CE) mark constitutes a manufacturer's declaration of conformity to applicable European directives and standards. Only those versions of Hypertherm products with a CE mark found on or near the data plate have been tested for compliance with the European Low Voltage Directive and the European Electromagnetic Compatibility Directive.

Declaration of conformity

This Declaration of Conformity applies to these HyPrecision Waterjet Pump models based on testing of the HyPrecision™ 50S model:

HyPrecision 15	HyPrecision 50S	HyPrecision 100D
HyPrecision 30	HyPrecision 60S	HyPrecision 150D
HyPrecision 50	HyPrecision 75S	

Date of first fixing of Conformité Européene (CE) mark (Declaration of Conformity issued): 15 June 2010

Product stewardship

Date of this Declaration of Conformity: 17 March 2014

This Declaration of Conformity was reissued because of a change to the product model name. No changes were made regarding safety.

Model units with a CE mark on the data plate meet the essential requirements of these European Union (EU) Directives using the relevant section of the EU standards and other normative documents.

- 97/23/EC Pressure Equipment Directive (PED)
- 2006/42/EC Machinery Directive
- 2006/95/EC European Low Voltage Directive
- 2004/108/EC European Electromagnetic Compatibility (EMC) Directive

This declaration is not valid on units without a CE mark on the data plate.

For European customer inquiries, contact:

European Customer Service
Hypertherm Europe B.V.
Vaartveld 9 4704 SE
Roosendaal, the Netherlands
+31(0)165 596907

To see the signed Declaration of Conformity in English, go to the Hypertherm web site at www.hypertherm.com.

1. Click **Downloads library**.
2. Select a HyPrecision product from the **Product type** dropdown list.
3. Click on the **Regulatory** folder that is shown below the search fields.
4. Click on the **EU Declaration of Conformity** folder.



These navigation instructions are subject to change without notice.

Differences in national standards

Nations can apply different performance, safety, or other standards. National differences in standards include, but are not limited to:

- Voltages
- Plug and cord ratings
- Language requirements
- Electromagnetic compatibility requirements

These differences in national or other standards can make it impossible or impractical for all certification test marks to be put on the same version of a product. For example, the Canadian Standards Association (CSA) versions of Hypertherm's products do not comply with European electromagnetic compatibility requirements and therefore do not have a CE mark on the data plate.

Countries that require a CE mark or have compulsory electromagnetic compatibility regulations must use CE versions of Hypertherm products with the CE mark on the data plate. These include, but are not limited to:

- Australia
- New Zealand
- Countries in the European Union
- Russia

It is important that the product and its certification test mark be suitable for the end-use installation site. When Hypertherm products are shipped to one country for export to a different country, the product must be configured and certified properly for the end-use site.

Higher-level systems

When an original equipment manufacturer (OEM) or system integrator adds equipment such as cutting tables, motor drives, motion controllers, or robots to a Hypertherm Waterjet cutting system, the combined system can be considered a higher-level system. A higher-level system with hazardous moving parts can constitute industrial machinery or robotic equipment, in which case the system integrator or end-use customer could be subject to more regulations and standards than those relevant to the waterjet cutting system as manufactured by Hypertherm.

It is the responsibility of the end-use customer and the OEM or system integrator to do a risk assessment for the higher-level system, and to supply protection against hazardous moving parts. Unless the higher-level system is certified when the OEM or system integrator incorporates Hypertherm products into it, the installation also can be subject to approval by local authorities. Seek advice from legal counsel and local regulatory experts if you are uncertain about compliance.

External interconnecting cables between parts of the higher-level system must be suitable for contaminants and movement as required by the final end-use installation site. When the external interconnecting cables are subject to oil, dust, water, or other contaminants, hard usage ratings could be required.

When external interconnecting cables are subject to continuous movement, constant flexing ratings could be required. It is the responsibility of the end-use customer or the OEM or system integrator to ensure the cables are suitable for the application. Since there are differences in the ratings and costs that can be required by local regulations for higher-level systems, it is necessary to verify that external interconnecting cables are suitable for the end-use installation site.

Proper disposal of Hypertherm products

Hypertherm waterjet cutting systems, like all products with electronics, can contain materials or parts, such as printed circuit boards, that can not be discarded with ordinary waste. It is your responsibility to dispose of Hypertherm product or part in an environmentally suitable manner and in compliance with national and local codes.

In the United States, check all federal, state, and local laws. In the European Union (EU), check the EU directives, national, and local laws. For more information, go to www.hypertherm.com/weee. In other countries, check national and local laws. Consult with legal or other compliance experts when applicable.

Proper handling and safe use of chemicals

Material safety data sheets (MSDS) and safety data sheets (SDS) are part of a hazard communication plan that supplies detailed information about hazardous chemicals. The information includes the chemical's toxicity and reactivity, first aid for exposure, approved storage and disposal, recommended protective equipment, and spill-handling procedures.

The Occupational Safety and Health Administration (OSHA) has presented new hazardous chemical labeling requirements as a part of its recent revision of the Hazard Communication Standard (29 CFR 1910.1200), to align with the United Nations' Globally Harmonized System of Classification and Labelling of Chemicals (GHS). The GHS is an international system for standardizing chemical classification and labeling.

Chemical regulations in the USA, Europe, and other locations require that Material Safety Data Sheets (MSDS) and Safety Data Sheets (SDS) be made available for chemicals that are supplied with the product and chemicals used in or on the product. The list of chemicals is supplied by Hypertherm. To see MSDS and SDS, go to the Hypertherm web site at www.hypertherm.com.

1. Click **Downloads library**.
2. Select **Material Safety Data Sheets** from the **Category** dropdown list.
3. Click on the **Material Safety Data Sheets** folder that is shown below the search fields.
4. Click on the **MSDS** folder.



These navigation instructions are subject to change without notice.

Particle emission and wastewater quality

Hypertherm does not manufacture or supply the materials that are cut and has no knowledge whether the particles released from materials that are cut will pose a physical hazard or health risk. Please consult with your supplier or other technical advisor if you need guidance concerning the properties of the material you will cut using a Hypertherm product.

If you are not fully aware of and up to date on all applicable government regulations and legal standards for the installation site, consult a local expert before purchasing, installing, and operating the equipment.

The end user is responsible for the safe operation of this equipment.

The safety precautions in this manual are general and can not anticipate every situation. Hypertherm Inc. acknowledges that unforeseen situations due to equipment failure, site variability, insufficient maintenance, failure of control equipment, and other events can cause equipment damage, injuries, or death. It is the user's responsibility to identify hazards and take the steps necessary to minimize risks.

Keep these instructions near the equipment. This manual is intended to familiarize the user with the equipment and its parts, operation, and maintenance.

All people who operate or are exposed to this equipment must know this information:

- Applicable safety standards
- The use, limitations, and care of personal protective equipment
- The location of the written hazard communication program and safety data sheets
- How to recognize hazardous energy sources
- The correct methods for isolating and controlling energy, including lock out–tag out procedures

User qualification and training

All users must read and understand these instructions before installing, operating, or doing maintenance on this equipment.

Do not permit an untrained person to operate a waterjet pump. Operators must be qualified to install, operate, and maintain this equipment. Training should include this information:

- How to start and stop the pump during routine operation and in an emergency situation
- The conditions and actions that can lead to injuries to people and damage to the pump
- How to operate all controls
- How to identify and respond to fault indicators
- How to do maintenance procedures
- A copy of this manual

This list is not all-inclusive.

Emergency medical information and treatment

The use of high-pressure equipment exposes the operator and other people in the area to high-pressure water. Potential harms include eye injuries, lacerations, infections, and amputations. Do not put ice or heat on a waterjet injury. Support injured limbs and extremities above heart level if possible.

A high-pressure injection injury is a surgical emergency. Seek immediate medical treatment for all high-pressure waterjet injuries. Delayed treatment can lead to serious injuries or death.













Waterjet operators should carry a waterproof emergency medical tag or card that describes the nature of high-pressure waterjet injuries and the recommended treatment.

Give this card to emergency responders and medical professionals. It can be copied, cut out, laminated, and folded.

 <p>MEDICAL INFORMATION</p> <hr/> <p>A high-pressure injection injury is a surgical emergency.</p> <p>Seek immediate medical treatment for all high-pressure waterjet injuries.</p> <p>Delayed treatment can lead to serious injuries or death.</p>	<p>The person carrying this card has been exposed to a waterjet of up to 4,137 bar (60,000 psi) and a velocity of 609 m/s (2,000 feet/second). The waterjet can contain abrasive materials. Skin can appear intact or show a minor pinhole-sized puncture wound. The injured area can become swollen, painful, and pale over the next 4 to 6 hours. Tissue becomes ischemic and necrotic within 12 hours.</p> <p>Consult a surgical specialist immediately for decompression, removal of foreign materials, and debridement.</p> <p>Administer broad-spectrum, intravenous antibiotics for Gram-negative and Gram-positive organisms.</p> <p>X-ray is the imaging of choice.</p> <p>Acute compartment syndrome is possible.</p> <p>Leave the wound open.</p>	<p>Do not use solvents other than isotonic sodium chloride solution for irrigating the wound.</p> <p>Do not use digital or local nerve blocks. Give analgesics by mouth or injection.</p>
---	--	---









Information and hazard symbols









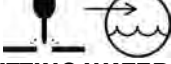
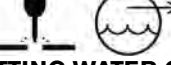

Some symbols in this table could be relevant to other products.

 DANGER	<p>This symbol identifies an imminently hazardous situation, which, if not avoided, will result in death or serious injury.</p>
 WARNING	<p>This symbol identifies a potentially hazardous situation, which, if not avoided, could result in death or serious injury.</p>
 CAUTION	<p>This symbol identifies a potentially hazardous situation, which, if not avoided, could result in minor or moderate injury, or property damage.</p>
 WARNING	<p>A waterjet is a cutting tool. A high-pressure injection injury is a surgical emergency. Seek immediate medical treatment for all high-pressure waterjet injuries. Delayed treatment can lead to serious injuries or death.</p>
	<p>High-pressure water can cause eye injuries. Wear approved eye protection when operating or working near this equipment.</p>
	<p>Prolonged exposure to noise can cause permanent hearing loss. Wear approved ear protection and control exposure time when operating or working near this equipment.</p>
	<p>High-pressure water can cause severe cuts or lacerations, abrasions, and punctures. Wear approved hand protection when operating or working near this equipment. Precision parts have sharp corners or edges. Wear protective gloves when handling parts.</p>
	<p>Some materials can produce airborne contaminants or suspended particles when cut. Wear approved respiratory protection.</p>
	<p>Refer to the instruction manual. Read and understand all of the safety guidelines in this manual.</p>
	<p>This symbol identifies a mandatory action.</p>
	<p>This symbol identifies a prohibited action.</p>
	<p>This symbol identifies tools or materials that are required or recommended for a procedure.</p>
	<p>This symbol identifies a note or helpful information.</p>

Symbols and marks found on the data plate and the pump

Some symbols or marks in this table could be relevant to other products.

 DANGER	To reduce the risk of serious injuries or death, wear approved protection and follow safety recommendations when working with electricity.
 WARNING	Do not touch a hot surface.
	Caution
	Refer to the instruction manual. Read and understand all of the safety guidelines in this manual.
	Correct direction of motor rotation (motor rotation arrow)
S/N	Serial number
V	Volts
Φ	Number of phases in a power system
Hz	Frequency (hertz)
FLA	Full-load current (amperage)
SCCR	Short-circuit current rating
IP	Ingress protection rating
 I_{max}	Primary motor maximum current draw (amperes)
 kW	Primary motor power output (kilowatts)
l/min	Maximum outlet flow rate (liters/minute)
MPa	Maximum outlet water pressure (megapascals)
DWG	System schematic drawing number
	<p>The Conformité Européene (CE) mark shows that a product complies with standards relevant to the product to which the mark is affixed.</p> <p>The CE mark signifies the manufacturer's declaration of conformity to applicable European directives and standards. Only those versions of products with a CE mark found on or near the data plate have been tested for compliance with the European Low Voltage Directive and the European Electromagnetic Compatibility (EMC) Directive.</p>

 AIR IN	<p>Compressed air that operates the bleed-down valve</p>
 COOLING IN	<p>Water-cooled pump: low-pressure cooling water from the local utility or a chiller that circulates through the heat exchanger Air-cooled pump: hydraulic fluid returning from an external air cooler</p>
 COOLING OUT	<p>Water-cooled pump: water from the heat exchanger that goes to a drain or a chiller Air-cooled pump: hydraulic fluid that is sent to an external air cooler</p>
 CUTTING WATER IN	<p>Low-pressure water from a softener or reverse osmosis system that goes to the intensifier; also called inlet cutting water</p>
 CUTTING WATER OUT	<p>High-pressure water from the intensifier that is used for cutting or piercing</p>
 WASTEWATER OUT	<p>Water from the bleed-down valve or the low-pressure system that goes to a drain</p>
 	<p>Prefilter water pressure</p>
 	<p>Postfilter water pressure</p>
 	<p>Cut pressure (high pressure)</p>
 	<p>Pierce pressure (low pressure)</p>
 	<p>Hydraulic pressure (for single- or redundant-intensifier pumps)</p>
 	<p>Hydraulic pressure pump 1 (for dual-intensifier pumps)</p>
 	<p>Hydraulic pressure pump 2 (for dual-intensifier pumps)</p>

Section 1

Terminology

Some terms could be relevant to other products.

attenuator

A pressure vessel that maintains consistent output water pressure by compensating for pressure fluctuations caused by the intensifier stroking

AWG

American Wire Gauge, a standardized wire gauge system used in North America

bar

A unit of pressure; 1 bar equals 100 kPa or 14.5 psi or 100,000 N·m²

computer numerical control (CNC) machine

A computer that controls the motion of a machine tool

cooling water

Low-pressure water that circulates through the heat exchanger to cool the hydraulic fluid

cSt

A centistoke is a measurement of kinematic viscosity; water has a viscosity of 1 centistoke or 1 mm²/second

cut-pressure mode (high-pressure mode)

Water that is at cutting pressure

cutting water (cutting water out)

High-pressure water from the intensifier that is used for cutting or piercing

dB(A)

A-weighted decibels, an expression of the relative loudness of sounds in air as perceived by the human ear

dynamic seal

The high-pressure seal in the high-pressure cylinder that is closest to the hydraulic center section; this seal is in direct contact with the plunger (see static seal)

Terminology

fitting

A coupling, valve, or gauge that stops, regulates, or directs the flow of water in a pipe

hard water

Water with dissolved minerals in it, typically calcium and magnesium

high-pressure mode (cut-pressure mode)

Water that is at cutting pressure

high-pressure water

Water that has been pressurized by the intensifier for cutting or piercing

hose

A flexible tube that carries low-pressure fluid

inlet cutting water (cutting water in)

Low-pressure water from a softener or reverse osmosis system that goes to the intensifier

ISO

The International Organization for Standardization is an independent membership organization that develops voluntary standards

JIC

JIC (Joint Industry Council) fittings are a type of flare fitting used in fluid delivery applications; these fittings are machined with a 37° flared seating surface and are composed of a fitting, a flare nut, and a sleeve

kPa

A kilopascal is a unit of pressure; 1 kPa equals 0.01 bar or 0.15 psi or 1,000 N·m²

lap

To rub a stainless steel surface against lapping paper to make the surface very smooth and flat

lockout-tagout

Lockout-tagout procedures protect workers from the unexpected starting of machinery and equipment and the release of hazardous energy during maintenance or repair activities.

low-pressure mode (pierce-pressure mode)

Water that is at a reduced pressure that is used to pierce the material to be cut; using a lower pressure prevents brittle materials from cracking

low-pressure water

Water that is not pressurized by the intensifier

NPT

National pipe thread taper, a common United States standard for tapered threads that are used on fittings and pipes

OEM

An original equipment manufacturer of machines that include Hypertherm products that are sold directly to end users

overstroke (fault)

An overstroke fault occurs when the hydraulic piston travels faster in 1 or both directions than the output water flow of the waterjet pump can support.

pierce-pressure mode (low-pressure mode)

Water that is at a reduced pressure that is used to make a hole in the material to be cut; using a lower pressure prevents brittle materials from cracking

pipe

A rigid tube that carries low-pressure fluid

psi

Pound-force per square inch is a unit of pressure; 1 psi equals 0.07 bar or 7 kPa or 6,894 N·m²

static seal

The high-pressure seal at the output end of the high-pressure cylinder; this seal does not touch the plunger (see dynamic seal)

system integrator

An integrator of waterjet cutting systems that include Hypertherm products that are sold directly to end users

reverse osmosis

A method for treating water by forcing it through a semipermeable membrane to remove impurities that can damage high-pressure parts

SAE

SAE International is a professional association of engineers and technical experts that coordinates the development of technical standards based on best practices in the aerospace, commercial vehicle, and automotive engineering; SAE Code 61 fittings are designed for 207-bar or 20,684-kPa (3000-psi) applications; SAE Code 62 fittings are designed for 414-bar or 41,369-kPa (6,000-psi) applications

tubing

A rigid tube that carries high-pressure fluid

valve

A device used to control the rate of flow in a pipe or a tube

weep hole

A small hole that is drilled into high-pressure fittings to let leaking water to escape

Section 2

Product description

This section gives a broad overview of the major parts of the pump and what they do. HyPrecision pumps use a hydraulic system to pressurize water for waterjet cutting.

Four systems make up the pump: hydraulic, low-pressure water, high-pressure water, and electrical. These systems are not independent of each other.

Color is used throughout the manual to identify the different systems.

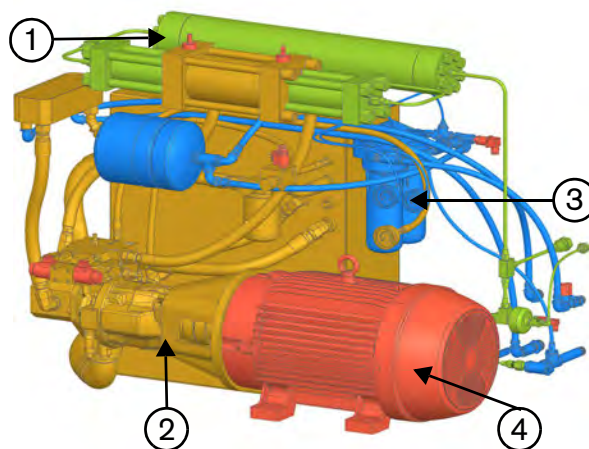

- | | |
|--------------------------------------|------------------------------------|
| 1 High-pressure water system (green) | 3 Low-pressure water system (blue) |
| 2 Hydraulic system (gold) | 4 Electrical system (red) |

 In the Preventive maintenance section, which begins on page 61, red is also used to highlight applicable parts.

Pump exterior

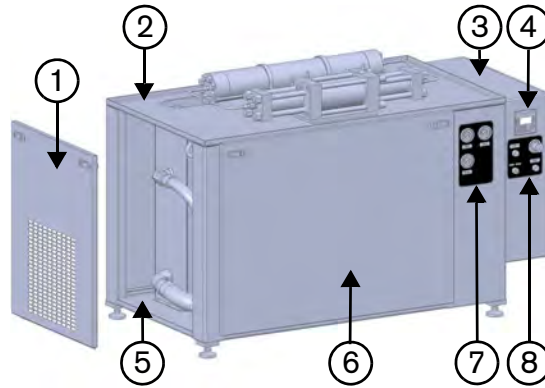

- 1 Side cover
- 2 Top deck
- 3 Electrical enclosure
- 4 Operator interface
- 5 Bottom deck
- 6 Front cover
- 7 Gauge panel
- 8 Operation panel

Gauge panel



Prefilter water pressure gauge

The prefilter gauge shows the pressure before the water goes through the filters. Normal operating range is 2.8 bar to 7.5 bar or 276 kPa to 758 kPa (40 psi to 110 psi).

Postfilter water pressure gauge

The postfilter gauge shows the pressure after the water goes through the filters. Normal operating range is 2.8 bar to 7.5 bar or 276 kPa to 758 kPa (40 psi to 10 psi).

Hydraulic pressure gauge

This gauge shows the hydraulic pressure in the pump.

To determine the approximate cutting water pressure, multiply the hydraulic pressure gauge value by 20.

	Hydraulic pressure		Cutting water pressure
	4,100 bar	× 20 =	82,000 bar
Example:	41,000 kPa	× 20 =	820,000 kPa
	3,000 psi	× 20 =	60,000 psi

Major systems

Hydraulic system

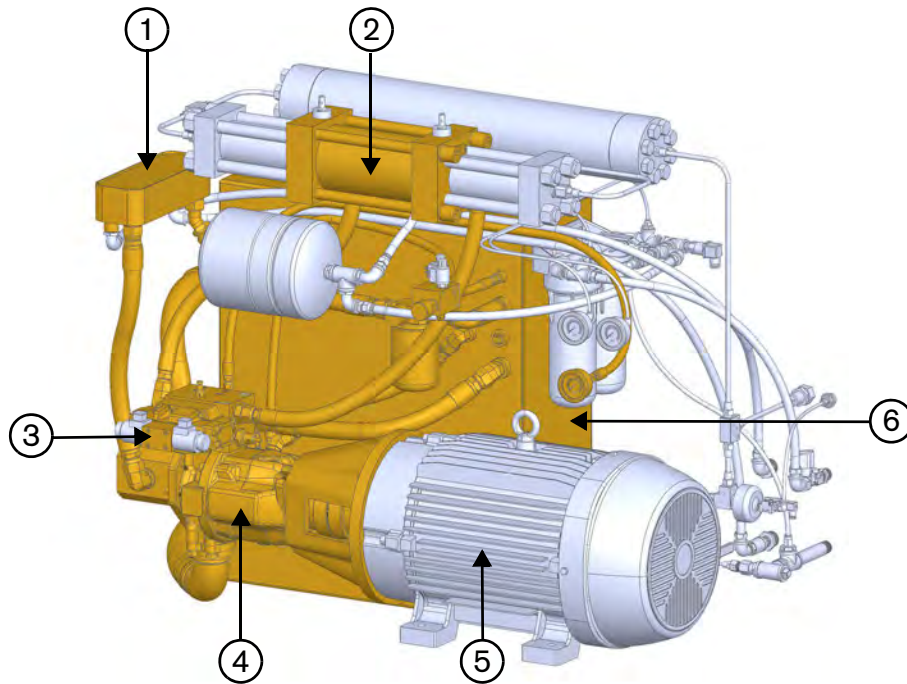

- | | |
|------------------------------|--------------------------|
| 1 Heat exchanger | 4 Primary hydraulic pump |
| 2 Hydraulic center section | 5 Primary motor |
| 3 Primary hydraulic manifold | 6 Hydraulic fluid tank |

The primary motor runs the primary hydraulic pump, which draws fluid from the hydraulic fluid tank and pressurizes it. The pressurized hydraulic fluid passes through the heat exchanger and the hydraulic filter to the primary hydraulic manifold, which contains a shift valve that alternates the supply of hydraulic fluid to each side of a reciprocating piston in the intensifier.

Inlet cutting water enters the high-pressure cylinder in the intensifier, where it is compressed by the piston to make high-pressure water for cutting or piercing.

Hydraulic fluid from the hydraulic center section in the intensifier returns to the hydraulic fluid tank through the primary hydraulic manifold.

The heat exchanger keeps the hydraulic fluid at its optimal temperature. A gear pump moves hydraulic fluid from the hydraulic fluid tank and sends it through the heat exchanger, where heat is transferred through fins to cooling water or to an optional fan. The hydraulic fluid passes through a hydraulic filter and then returns to the hydraulic fluid tank.

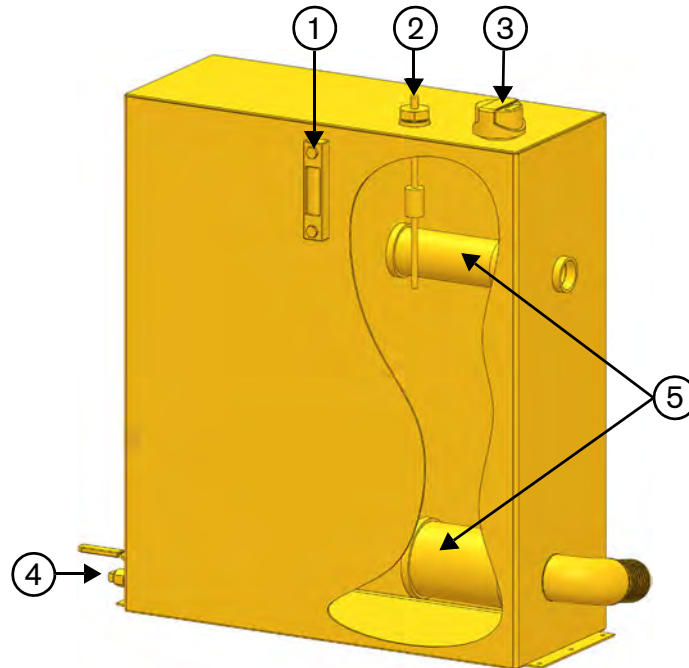
Hydraulic fluid tank

- | | | | |
|---|------------------------------|---|-------------------|
| 1 | Sight gauge | 4 | Drain |
| 2 | Temperature and level sensor | 5 | Suction strainers |
| 3 | Filler-breather cap | | |

A filler-breather cap keeps the contents of the tank free of airborne contaminants and permits access to the tank for adding hydraulic fluid. A sight gauge permits observation of the hydraulic fluid level and quality. A temperature and level sensor monitors the hydraulic fluid. Suction strainers prevent contaminants from entering the primary pump and the gear pump. Open the ball valve to drain the tank.

2 – Product description

Primary hydraulic manifold

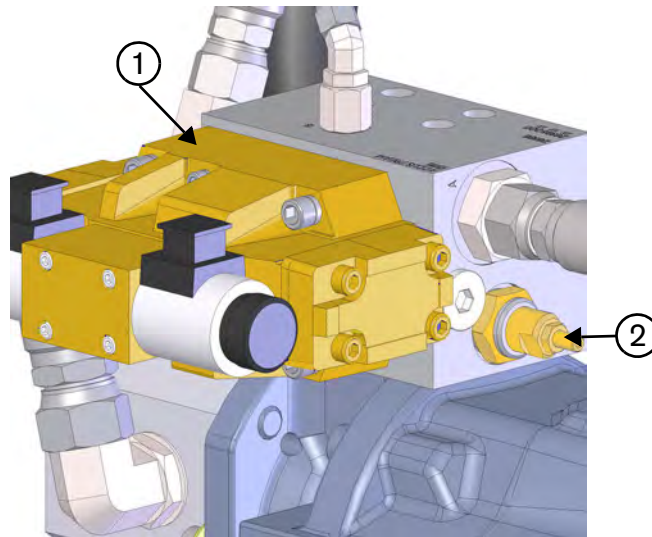

1 Shift valve

2 Relief valve

A shift valve mounted on the manifold directs the flow of pressurized hydraulic fluid to alternating sides of the piston in the intensifier. A relief valve protects the pump from too much pressure.

Intensifier

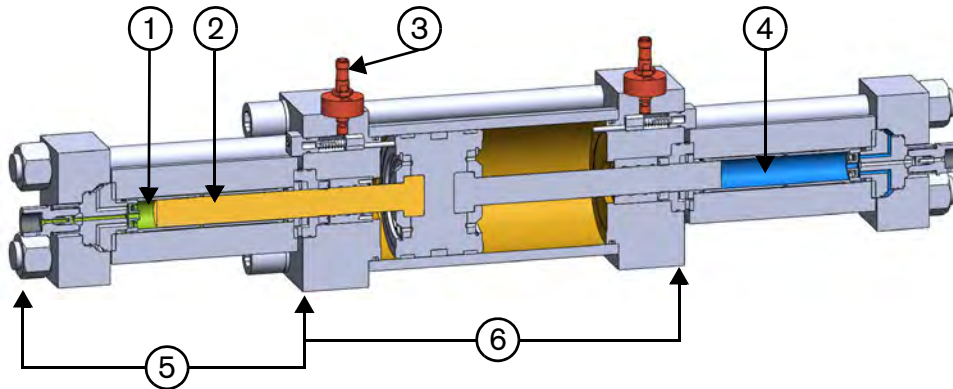

1 High-pressure water

2 Plunger

3 Proximity switch

4 Low-pressure water

5 High-pressure end

6 Hydraulic center section

A proximity switch at each end of the hydraulic center section signals a shift valve to direct the flow of pressurized hydraulic fluid to alternating sides of the piston in the intensifier.

Ceramic plungers connected to each side of the piston extend into the left and right high-pressure ends. Hydraulic fluid pushes the piston to 1 side while low-pressure water fills the empty cylinder. The plunger on the opposite side of the cylinder compresses high-pressure water for cutting or piercing.

Hydraulic control manifold

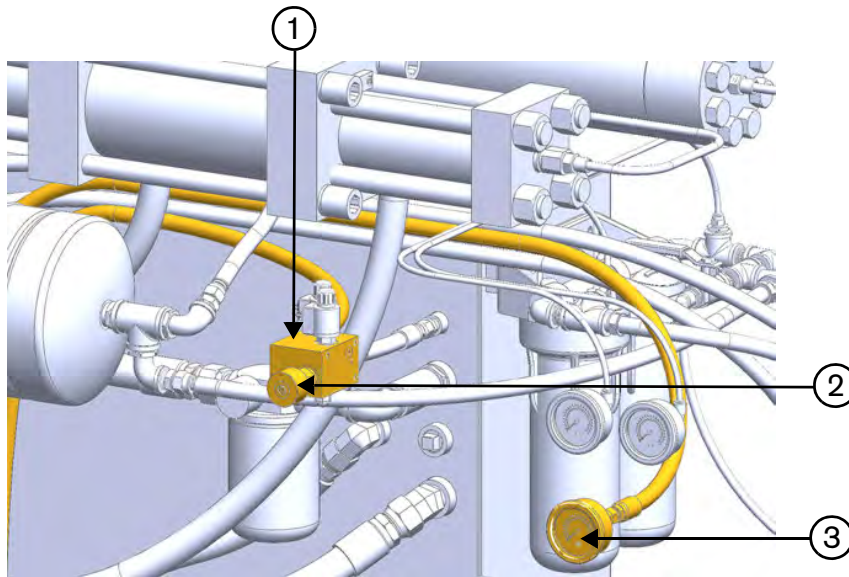

1 Hydraulic control manifold

3 Hydraulic pressure gauge

2 Pierce-pressure adjustment knob

Standard pumps are equipped with a hydraulic control manifold, which includes a pierce-pressure adjustment knob, a solenoid valve that changes the pierce pressure, and a solenoid valve that turns the pump pressure on and off. A hydraulic pressure gauge shows the pressure in the manifold.

Pressure compensator

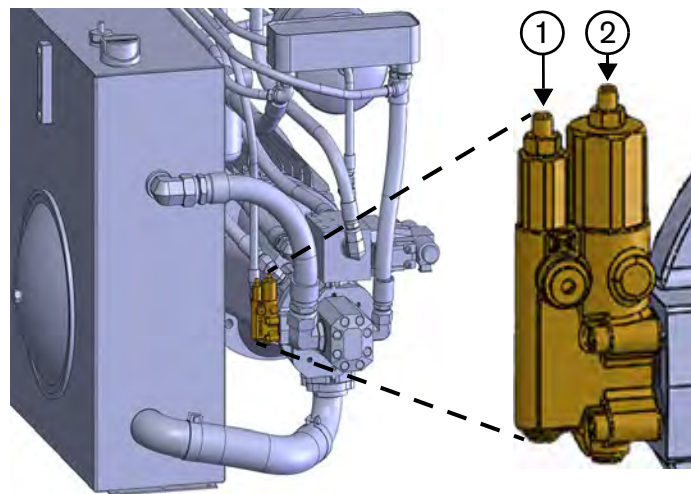

1 Compensating valve

2 Differential pressure valve

The pressure compensator controls cutting water pressure by limiting the minimum and maximum hydraulic fluid pressure to the intensifier.

The compensating valve limits the maximum pump pressure. The differential pressure valve limits the minimum hydraulic pressure.

2 – Product description

Cooling loop

Compressing hydraulic fluid generates substantial heat that can damage equipment and decrease the life of the fluid. A cooling loop keeps the hydraulic fluid at its optimal temperature. The heat exchanger, gear pump, hydraulic fluid, and low-pressure cooling water or an external fan make up a cooling loop.

Water-cooled heat exchanger (standard)

When the primary motor is running, cooling water circulates through the heat exchanger, transferring heat away from the hydraulic fluid to the cooling water.

Air-cooled external heat exchanger (optional)

The gear pump directs hydraulic fluid to an external radiator. When the temperature of the hydraulic fluid in the hydraulic fluid tank is higher than 54.4°C (130°F) a fan forces ambient air over cooling fins to cool the hydraulic fluid. The fan runs for at least 10 minutes. If the hydraulic fluid temperature is lower than 46.1°C (115°F) after 10 minutes, the fan turns off. If the hydraulic fluid temperature is higher than 46.1°C (115°F) after 10 minutes, the fan continues running.

Low-pressure water system

The low-pressure water system includes the inlet cutting water. In water-cooled systems it also includes a cooling water loop and a heat exchanger.

Inlet cutting water

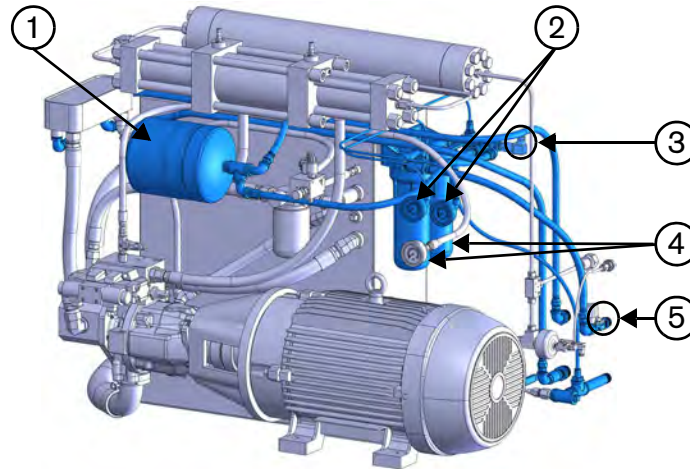

- | | |
|-----------------------------|-----------------------|
| 1 Accumulator | 4 Water filters |
| 2 Water pressure gauges | 5 Inlet cutting water |
| 3 Low-pressure water switch | |

Inlet cutting water (CUTTING WATER IN) from a water softener or a reverse osmosis system flows through 2 water filters to remove contaminants. Water pressure gauges show the water pressure before and after water goes through the filters. A low-pressure water switch after the filters tells the programmable controller if the water pressure is higher than the minimum required. Filtered water collects in the accumulator, which equalizes the water pressure. The water enters the high-pressure ends in the intensifier where it is compressed to make high-pressure water for cutting or piercing (CUTTING WATER OUT).

2 – Product description

Cooling water (for water-cooled systems)

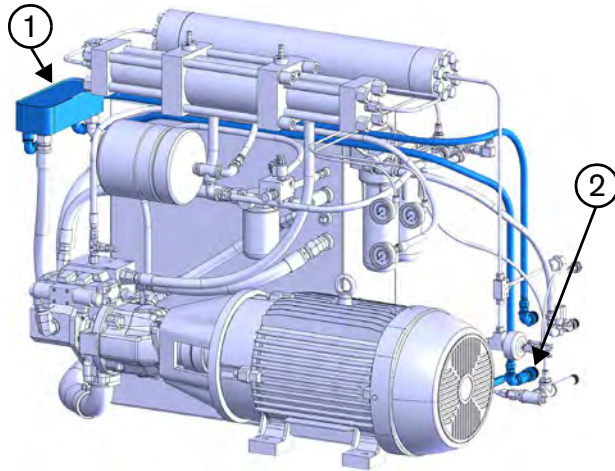

1 Heat exchanger

2 Ball valve

When the primary motor is running, low-pressure cooling water from the local utility or a chiller (COOLING IN) circulates through the heat exchanger, drawing heat away from the hydraulic fluid. Water from the heat exchanger exits the cooling system to a drain or is recycled to a chiller (COOLING OUT).

Hydraulic temperature is controlled by adjusting the flow rate of the cooling water with a manual ball valve or an optional water-modulating valve.

High-pressure water system

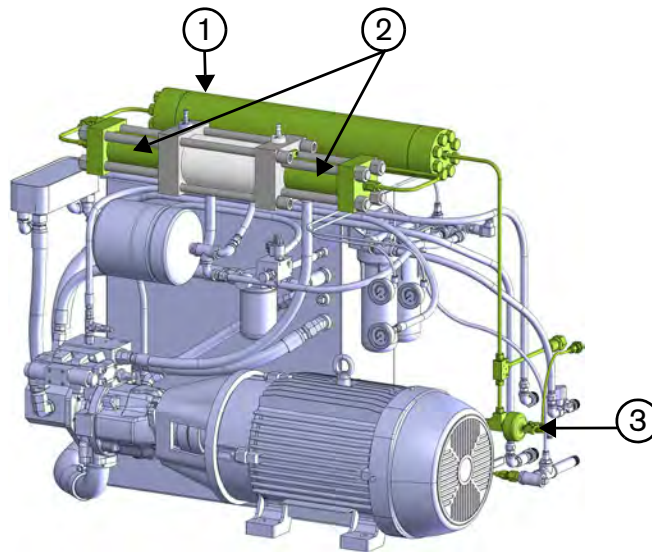

1 Attenuator

2 High-pressure ends

3 Bleed-down valve

The plungers in the intensifier compress water up to 4,137 bar or 413,685 kPa (60,000 psi). This pressurized water exits the high-pressure end through a check valve and goes to the attenuator.

Attenuator

The stroking of the piston generates a brief change of water pressure in the high-pressure ends, causing the water pressure to drop. The attenuator reduces pressure fluctuations caused by reversal of the intensifier.

High-pressure ends

Ceramic plungers connected to each side of the piston extend into the left and right high-pressure cylinders. Hydraulic fluid pushes the piston to 1 side while inlet cutting water fills the empty cylinder. The plunger on the opposite side of the cylinder compresses high-pressure water for cutting or piercing.

Bleed-down valve

The bleed-down valve is a normally open, air-actuated dump valve. When the pump is turned off or it is changed from cut (high) pressure to pierce (low) pressure, the valve opens to discharge high-pressure water from the system.

2 – Product description

Electrical system

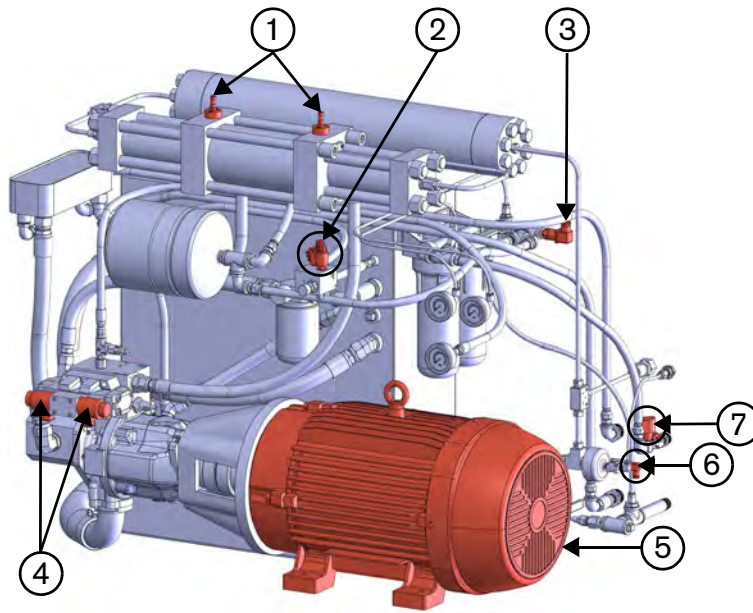

- 1 Proximity switches
- 2 Hydraulic control solenoid
- 3 Low-pressure water switch
- 4 Shift valve solenoids
- 5 Primary motor
- 6 Air bleed-down solenoid
- 7 Cutting water valve

The pump uses 3-phase alternating current (AC) electricity. Some parts such as valve solenoids and sensors use 24-volt direct current (DC) electricity from a power supply in the electrical enclosure.

End-of-travel sensing

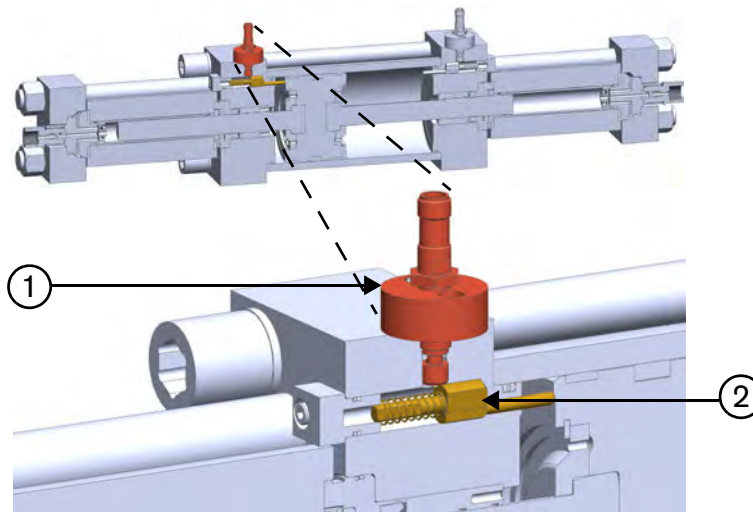

- 1 Proximity sensor
- 2 Indicator pin

When hydraulic fluid forces the piston to the end of the hydraulic center section, the piston pushes against a spring-loaded indicator pin. A signal from the proximity sensor above the indicator pin causes the shift valve in the primary hydraulic manifold to change the direction of the intensifier.

Primary motor

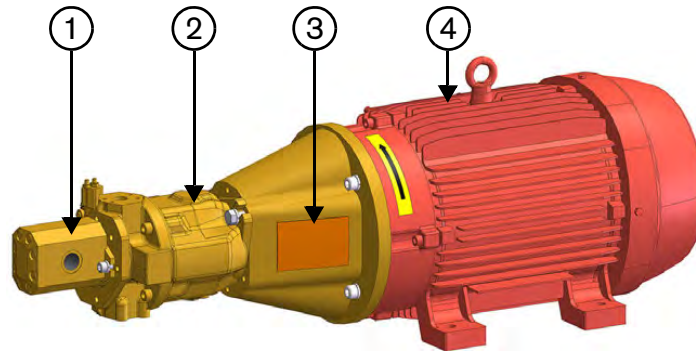

- | | |
|--------------------------|----------------------|
| 1 Gear pump | 3 Shaft access cover |
| 2 Primary hydraulic pump | 4 Primary motor |

The primary motor drives the primary hydraulic pump that moves hydraulic fluid through the intensifier and a gear pump that moves hydraulic fluid through the cooling loop.

Electrical enclosure

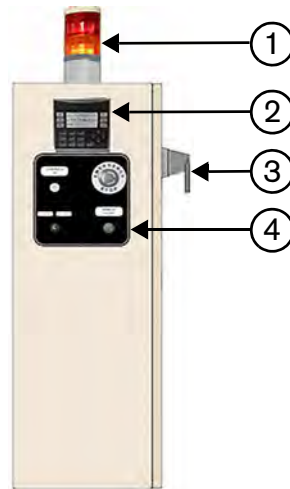

- | | |
|----------------------|------------------------------------|
| 1 Stack light | 3 Primary breaker disconnect lever |
| 2 Operator interface | 4 Operation panel |

Status indicators, pump control parts, and the primary breaker disconnect lever are on the outside of the electrical enclosure. The motor starter, the thermal overload relay, and the system breakers are inside the enclosure.

The stack light illuminates when the system detects a warning or fault condition.

The operator interface is a programmable controller for the pump and the intensifier. A series of screens permits the operator to turn the pump on and off and to change some pump settings. The primary screen shows information about warnings and faults.

The primary breaker disconnect lever disconnects electricity to the pump motor and controls.

The operation panel turns the control circuit inside the pump on and off and switches between local and remote pump operation.

2 – Product description

Micro SD card

A micro SD card inside the enclosure is used to load updates to the control software or to back up the program.

Motor starter

The HyPrecision 15 and 30 models have a motor starter contactor. A thermal overload relay is mounted to the bottom of the contactor.

The HyPrecision 50 model contains a wye-delta reduced-voltage starter. When the primary motor is turned on, the primary and wye contactors reduce the initial voltage to the starter. The starter runs until the timer expires. The timer is set at the factory to 3 seconds.

The timer relay transfers power to the delta and primary contactors, which run at full voltage and torque. When the contactors receive a signal to turn the pump off, the delta and primary contactors open and the motor turns off.

HyPrecision 15, 30, and 50 pumps are available with these optional features.

Voltage

50 Hz	60 Hz
400 V	460 V
	208 V to 230 V

Refer to the data plate or the system schematic drawing for the voltage of the pump.









Air-cooled external heat exchanger

Standard pumps are equipped with a water-cooled heat exchanger. In an air-cooled configuration, the temperature sensor in the hydraulic fluid tank turns on an external air-cooled heat exchanger.



Water-modulating valve

Standard pumps are equipped with a ball valve that permits manual adjustment of the cooling water. The water-modulating valve replaces the ball valve. A temperature sensor in the hydraulic fluid tank signals the valve to adjust cooling water flow to the heat exchanger.

Safety

	Refer to the instruction manual. Read and understand all of the safety guidelines in this manual.
 WARNING	A waterjet is a cutting tool. A high-pressure injection injury is a surgical emergency. Seek immediate medical treatment for all high-pressure waterjet injuries. Delayed treatment can lead to serious injuries or death.
 WARNING	Do not operate the pump without the shaft access cover and all other safety devices correctly installed. Do not remove guards while the pump is operating.
 WARNING	Eye, ear, and respiratory protection, safety shoes, and other personal protective equipment are recommended. Failure to wear personal protective equipment can result in injuries or death.
 WARNING	Do not touch a hot surface. Fittings can get hot, especially when they are not properly tightened.
 CAUTION	If a water line, fitting, or valve might be frozen, do not operate the pump. Thaw the system until water moves freely through the entire water circuit.
	High-pressure water can cause eye injuries. Wear approved eye protection when operating or working near this equipment.
	This waterjet system might exceed national and local codes for permitted noise levels. When this pump is running, the noise level is 80 to 85 dB(A). Noise level is related to factors such as water flow rate, pipe layout, and the acoustical characteristics of the building. Prolonged exposure to noise can cause permanent hearing loss. Wear approved ear protection and control exposure time when operating or working near this equipment.
	High-pressure water can cause severe cuts or lacerations, abrasions, and punctures. Wear approved hand protection when operating or working near this equipment.

4 – Operation

	Some materials can produce airborne contaminants or suspended particles when cut. Wear approved respiratory protection.
	Examine and clean the pump regularly. Make repairs immediately.
	Keep the work area clean and free of fluid spills.

 Hypertherm products are designed and manufactured with a commitment to continuous quality control and safety. Contact a Hypertherm Technical Service Associate for information about the installation, operation, maintenance, and repair of this equipment.

Overview

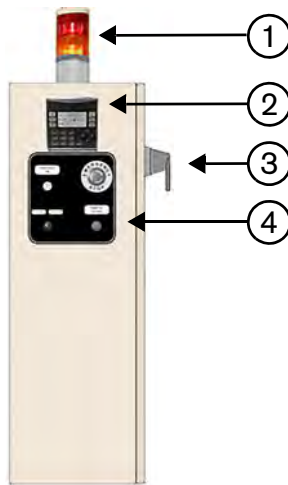

- 1 Stack light
- 2 Operator interface
- 3 Primary breaker disconnect lever
- 4 Operation panel

Status indicators, pump control parts, and the primary breaker disconnect lever are on the outside of the electrical enclosure.

Stack light

The stack light illuminates when the system detects a warning or fault condition. The amber stack light blinks to signal a condition that requires attention. The red stack light blinks to show that a fault has occurred.

Operator interface



- | | | | |
|---|----------------|---|------------------|
| 1 | Hour meter | 4 | Date and time |
| 2 | F1 and F2 | 5 | Enter |
| 3 | Numeric keypad | 6 | Direction arrows |

The operator interface is a programmable controller for the pump and the intensifier. A series of screens shows equipment status and permits the operator to operate the pump and intensifier.

 The operator interface described in this section is the standard controller for this pump. Some original equipment manufacturers (OEMs) or system integrators might change the controller. In these cases, refer to the documentation provided by the OEM or system integrator for operation instructions.

Operation panel



- | | | | |
|---|-------------------------|---|-------------------------------|
| 1 | CONTROLS ON button | 3 | EMERGENCY STOP pushbutton |
| 2 | LOCAL/REMOTE key switch | 4 | REMOTE ACTIVE indicator light |

The operation panel turns the control circuit inside the pump on and off and switches between local and remote pump operation.

The CONTROLS ON button turns on the controls. The controls must be on to operate the pump.

The EMERGENCY STOP pushbutton turns off the control circuit inside the pump, which turns off the pump, primary motor, and intensifier, and opens the bleed-down valve to discharge high-pressure water from the system.

When the LOCAL/REMOTE key switch is in the LOCAL position, the pump operates normally. When the key switch is in the REMOTE position, the remote source controls the pump and the REMOTE ACTIVE indicator light is on.

Primary breaker disconnect lever

4 – Operation

The primary breaker disconnect lever disconnects electricity to the pump motor and controls.

Inspect the pump before operation

Examine the equipment before starting the pump.

- Look for leaks, deterioration, damage, or other conditions that can interfere with operation.
- Make sure that all connections and fasteners are tight, including locking devices, bolts, hoses, and fittings.
- Check the sight gauge on the hydraulic fluid tank. If necessary, add hydraulic fluid.

Turn on the pump



Do not leave waterjet cutting equipment turned on and unattended.

The primary motor drives a primary hydraulic pump that moves hydraulic fluid through the intensifier and a gear pump that moves hydraulic fluid through the cooling loop. In this section, “pump on” means that the primary motor is running and the pumps are on. “Pump off” means that the motor and the pumps are off.

1. If the pump turned off because of a fault, correct the fault.
2. If the pump turned off because the EMERGENCY STOP pushbutton was pressed, reset the pushbutton on the operation panel by turning it in the direction of the arrows (clockwise) until it pops out.
3. Make sure that the water to the pump is turned on. Check the water lines for leaks.
4. Make sure that the electrical main is turned on.
5. Make sure that the primary breaker disconnect lever on the electrical enclosure door is in the ON position.

Turn on the pump locally



1. Turn the LOCAL/REMOTE key switch on the operation panel to LOCAL. When the key switch is in the LOCAL position, the pump operates normally and the REMOTE ACTIVE indicator light is off. The operator interface is the primary point of control.
2. Press the CONTROLS ON button to turn on the control circuit inside the pump. The CONTROLS ON button lights when the pump controls are on.



The pump can not be turned on until the control circuit is on.

3. Press F1 on the operator interface to start the pump in running mode.

4. Check the high-pressure water, low-pressure water, and hydraulic systems for leaks.

 WARNING	Use a piece of cardboard or other solid material to check for leaks when the pump is on. Do not use hands, cloth, paper, or towels.
 WARNING	Do not attempt to repair a leak with pressure in the system.

Turn on the pump remotely

 If the pump is turned off with the EMERGENCY STOP pushbutton or as the result of a fault, the pump can not be turned on remotely. If the pump is connected to a remote source and is using the remote CONTROLS ON function, refer to the remote-source manufacturer's instructions for an emergency stop reset.

1. Turn the LOCAL/REMOTE key switch on the operation panel to REMOTE. When the key switch is in the REMOTE position, the following states are true:
 - The remote source, such as a computer numerical control (CNC) operator console, controls the pump.
 - The REMOTE ACTIVE indicator light is on.
 - The CONTROLS ON button is not active.
 - Most normal operation from the operator interface is disabled. The only option available on the operator interface is the PUMP OFF function.
2. If the pump is connected to a remote source and is not using the remote CONTROLS ON function, follow these steps.
 - a. Turn the key switch to LOCAL.
 - b. Press the CONTROLS ON button.
 - c. Turn the key switch to REMOTE.

Operate the pump



When an original equipment manufacturer (OEM) or a system integrator makes a cutting system by combining Hypertherm equipment with other equipment, the end-use customer and the OEM or the system integrator are responsible for supplying protection against hazardous moving parts.

Hypertherm Inc. recommends taking these actions to prevent operator injury and equipment damage:

- Read and understand the instruction manual supplied by the OEM or the system integrator.
- Maintain a restricted-access area larger than the maximum movement range of the cutting system's moving parts.
- Where there is a risk of a collision, do not permit people or equipment near the cutting system's moving parts.
- Prevent accidental contact with the touchscreen or joystick on the computer numerical control (CNC) machine. Accidental contact can cause unexpected operation that can result in unintended motion.
- Do not do maintenance, repair, or clean the machinery during operation.
- If maintenance or repair is required, enable the safety interlock or disconnect and lock out–tag out the primary power to disable the motors and prevent motion.
- Permit only qualified people to operate, maintain, and repair this machinery.

Operator interface



- | | |
|------------------|--------------------|
| 1 Hour meter | 4 Date and time |
| 2 F1 and F2 | 5 Enter |
| 3 Numeric keypad | 6 Direction arrows |

The hour meter on the top left of the operator interface screen shows the total hours the pump has been in operation. The current date and time are on the top right. These are on every screen.

Four screens are used to operate the pump: the primary screen, the pump running screen, the cooling mode screen, and the intensifier settings screen. A series of alarm screens is also available to diagnose and resolve faults.

Alarm screens

When the programmable controller detects a fault condition, an alarm screen shows information about the problem and the stack light blinks. If this occurs, refer to the Troubleshooting section, which begins on page 153.

4 – Operation

Primary screen



- Press F1 to turn on the pump and the intensifier.
- Press F2 to turn on the pump in cooling mode.
- Press 1 on the numeric keypad to go to the intensifier settings screen.

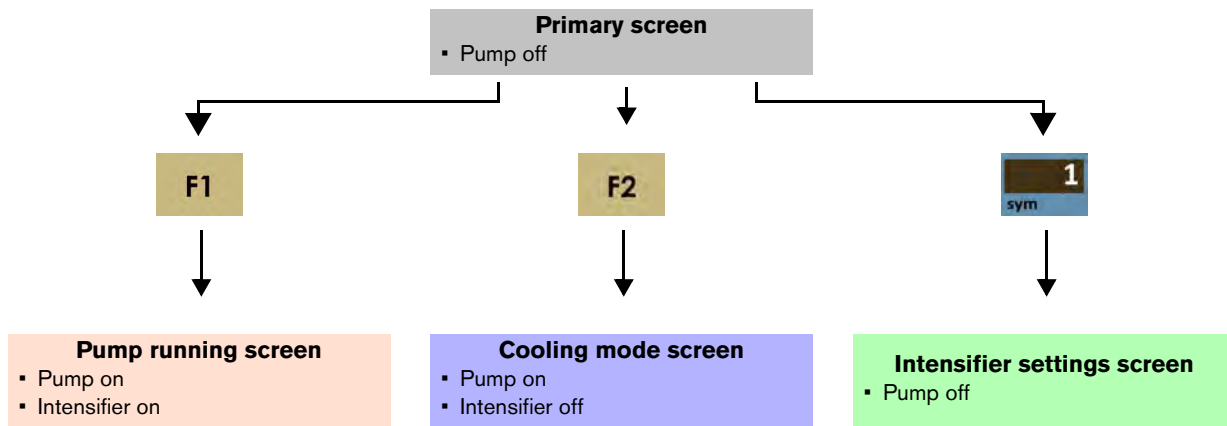

Pump running screen

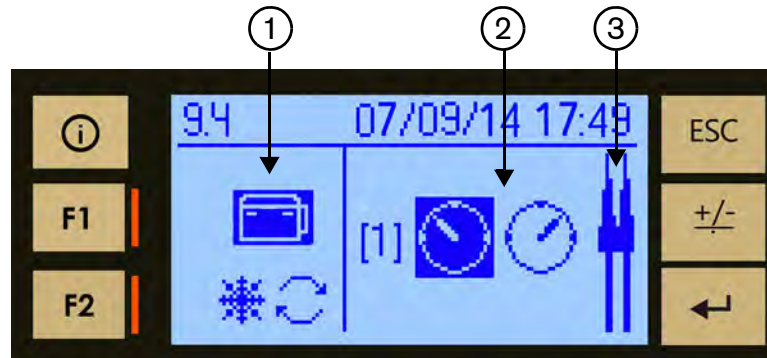

- 1 Pump symbol
- 2 Pump pressure mode indicator
- 3 Intensifier stroke rate indicator

When the pump symbol blinks, the pump is running.

- Press F1 to turn off the pump.
- Press F2 to put the pump in cooling mode.
- Press 1 on the numeric keypad to change to pierce-pressure or cut-pressure mode.

The screen also shows the intensifier stroke rate.

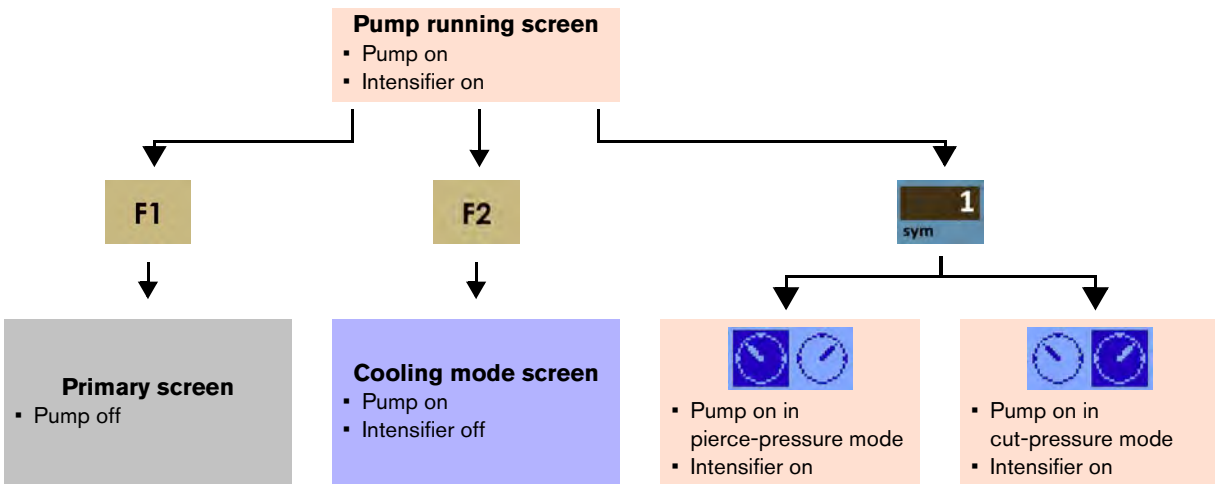

4 – Operation

Adjust the pierce pressure

The pierce-pressure adjustment knob is on the front of the hydraulic control manifold behind the pump's front cover. The hydraulic gauge shows the hydraulic fluid pressure.

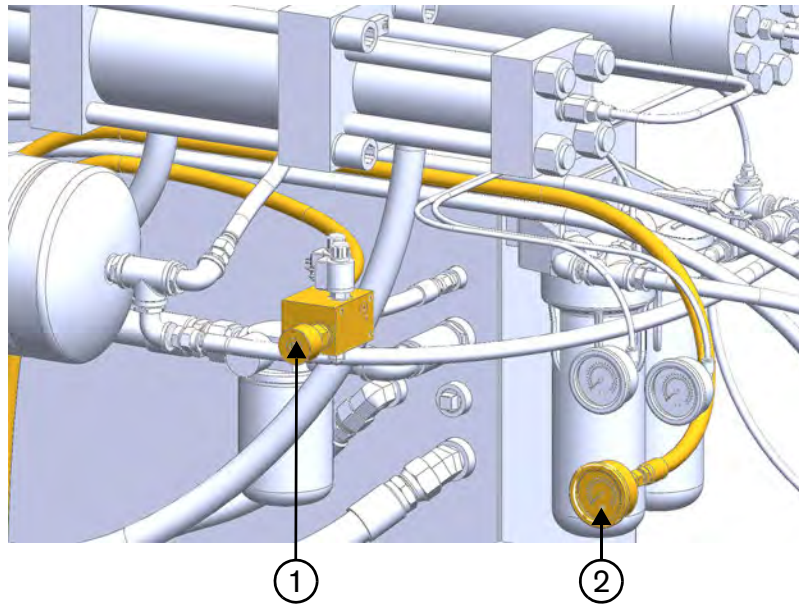

1 Pierce-pressure adjustment knob

2 Hydraulic pressure gauge

Do this with the pump running in pierce-pressure mode.



Required tools, materials, and parts

1/2-inch open-ended wrench

1. Use an open-ended wrench to loosen the jam nut behind the pierce-pressure adjustment knob.

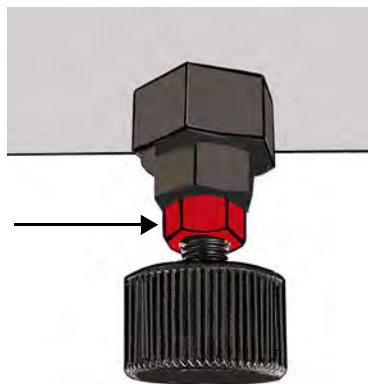

2. Turn the pierce-pressure adjustment knob to the right (clockwise) to increase the pierce pressure.
Turn the pierce-pressure adjustment knob to the left (anticlockwise) to decrease the pierce pressure.
3. Tighten the jam nut.

Adjust the cut pressure

The compensator has a compensating valve that limits the maximum cutting water pressure, which is set at the factory at 217 bar or 2,1718 kPa (3,150 psi). This setting can be adjusted.

 The differential pressure valve limits the minimum hydraulic pressure. The differential pressure valve is set at 21 bar or 2,068 kPa (300 psi). If the differential pressure valve requires adjustment, contact Hypertherm Technical Service for support.

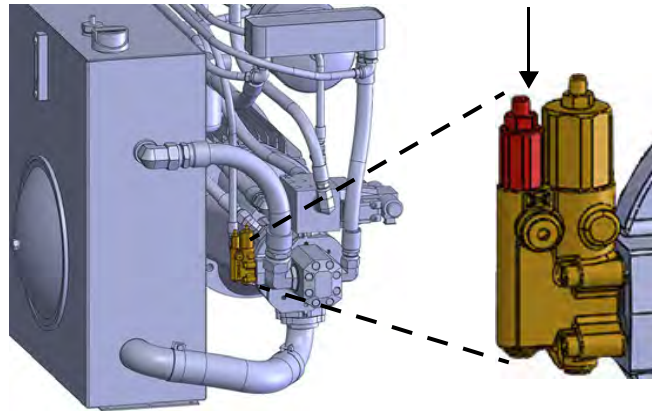

Compensating valve



Required tools, materials, and parts

- 13 mm open-ended wrench (for a compensator with a cap)
- 17 mm open-ended wrench (for a compensator without a cap)
- 3 mm hex wrench

Do this with the pump running and the intensifier disabled. Refer to page 57 for instructions for disabling and enabling the intensifier.

1. If the compensator has a cap, remove it.

 The sealing washer under the cap might stick to the cap. The compensator will leak if the washer is not in position when the cap is installed.

2. Use an open-ended wrench to loosen the jam nut 1 full turn (anticlockwise).
3. Use a 3 mm hex wrench to turn the adjustment screw to the right (clockwise) to increase pressure or to the left (anticlockwise) to reduce the pressure.



Do not adjust the hydraulic pressure higher than 217 bar or 21,718 kPa (3,150 psi). This can damage the hydraulic and high-pressure systems.

4. Tighten the jam nut.
5. If the compensator has a cap, put it back on the compensator.

4 – Operation

Cooling mode screen

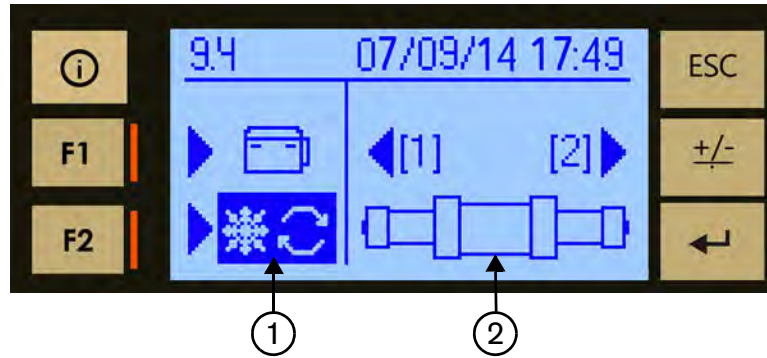

1 Cooling symbol

2 Intensifier enabled symbol

When the cooling symbol blinks, the pump is in cooling mode.

- Press F1 to turn on the pump and the intensifier.
- Press F2 to turn off the pump.
- Press 1 on the numeric keypad to shift the intensifier to the left.
- Press 2 on the numeric keypad to shift the intensifier to the right.

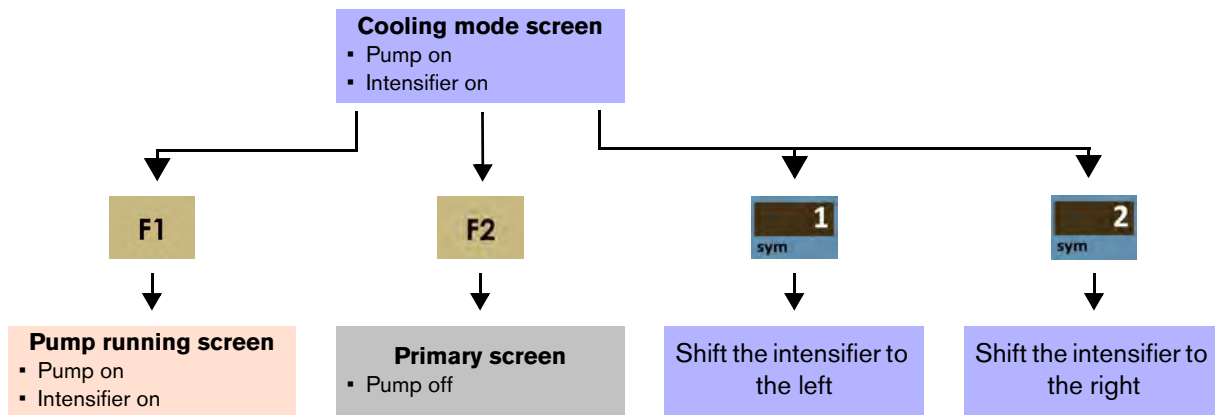

Intensifier settings screen

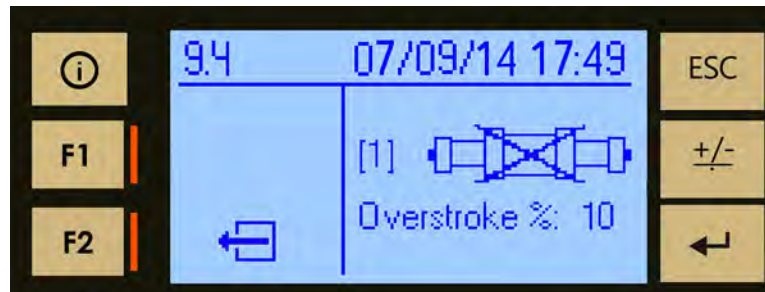

- Press 1 on the numeric keypad to enable or disable the intensifier.
- Press enter to adjust the overstroke percentage.

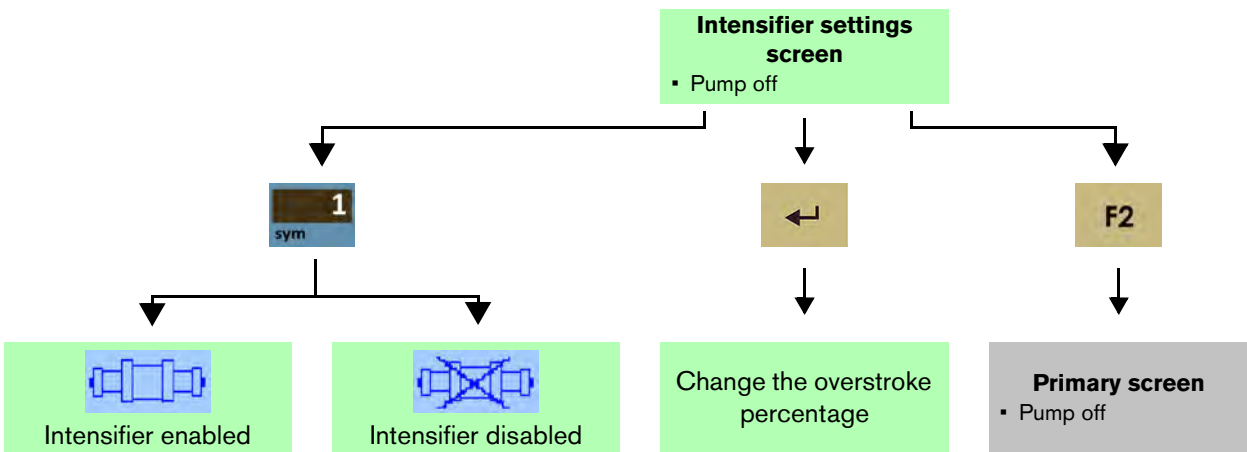

Adjust the overstroke percentage

1. Press enter. The overstroke percentage and the intensifier symbol blink.

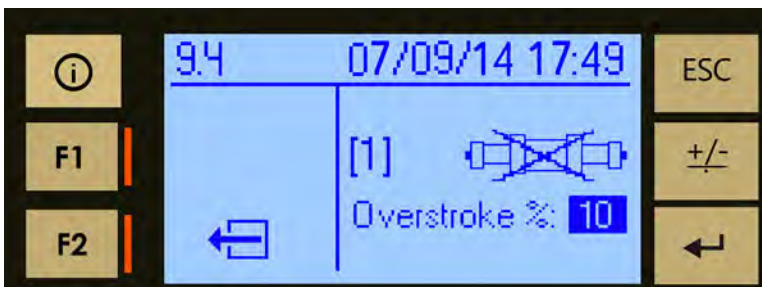

2. Use the numeric keypad to change the overstroke percentage.
3. Press enter to accept the change.

Operate the pump remotely

Refer to the remote-source manufacturer's instructions for operating the pump from a remote source.

CONTROLS ON	<p>This turns on the controls by turning on the primary control relay. The controls must be turned on before other commands can be used.</p> <p>If the pump is off, this turns on the primary control relay.</p> <p> If the pump is turned off with the EMERGENCY STOP pushbutton or as the result of a fault, the pump can not be turned on remotely.</p>
EMERGENCY STOP	<p>The EMERGENCY STOP pushbutton is available on the operation panel and at the remote control source.</p> <p>If the pump is running, this turns off the pump.</p>
PUMP ON	<p>This turns on the primary motor, the supply water, the cooling fan, and the fan starter motor. (The cooling fan is optional for air-cooled pumps.) The intensifier strokes in pierce-pressure mode for a time that is set at the operator interface. When the timer expires, the intensifier strokes to cut-pressure mode.</p> <p>If the pump is in cooling mode, this causes the intensifier to start stroking.</p>
PUMP OFF	<p>This turns off the primary motor and the supply water. In air-cooled pumps, it also turns off the fan motor starter and the cooling fan.</p>
COOLING ON	<p>If the pump is running, this turns off the intensifier.</p> <p>If the pump is off, this turns on the primary motor and the cooling water or the cooling fan.</p>

 If the pump is connected to a remote source and is using the remote CONTROLS ON function, refer to the remote-source manufacturer's for an emergency stop reset.

Stop the pump

Emergency stop

The EMERGENCY STOP pushbutton is intended for urgent disabling of the controls. It is not the preferred method of turning off the pump.

Press the EMERGENCY STOP pushbutton.

- The control circuit turns off, which causes the pump, primary motor, and intensifier to turn off.
- The bleed-down valve opens and discharges high-pressure water from the system.
- The CONTROLS ON button indicator light turns off.

Routine stop during operation

1. Turn OFF the cutting head.
2. Press F1 on the operator interface to turn off the primary motor. The bleed-down valve opens and discharges high-pressure water from the system.

Routine stop at the end of the day

1. Turn OFF the primary breaker disconnect lever on the electrical enclosure door. The operator interface screen turns off.
2. Turn OFF the water to the pump.

Section 5

Preventive maintenance













Hypertherm products are designed and manufactured with a commitment to continuous quality control and safety. Contact a Hypertherm Technical Service Associate for information about the installation, operation, maintenance, and repair of this equipment.







Hypertherm Inc. recommends preventive and scheduled maintenance for HyPrecision pumps. High-quality equipment that is serviced on a schedule lasts longer than equipment that is not regularly maintained. This maintenance includes, but is not limited to, adjustments, cleaning, lubrication, repairs, and replacement of parts.

Benefits of preventive maintenance

- Improves reliability
- Finds potential problems before they cause unplanned downtime and become expensive repairs
- Extends the life of equipment and decreases the frequency of replacement
- Contributes positively to reputation and profits
- Creates traceability through records

Safety

	Refer to the instruction manual. Read and understand all of the safety guidelines in this manual.
 DANGER	To reduce the risk of serious injuries or death, wear approved protection and follow safety recommendations when working with electricity.
 DANGER	<p>People who maintain and repair this equipment can be injured or killed if hazardous energy is not properly controlled. Injuries can include burns, cuts, fractures, or electrocution.</p> <p>Turn off electrical power before starting maintenance or repairs.</p> <p>Disconnect and lock out–tag out the primary power before opening the electrical enclosure or doing maintenance or repair procedures on this equipment.</p>
 WARNING	<p>A waterjet is a cutting tool. A high-pressure injection injury is a surgical emergency. Seek immediate medical treatment for all high-pressure waterjet injuries. Delayed treatment can lead to serious injuries or death.</p> <p>Keep skin away from high-pressure streams and leaks. Pressurized fluid can cause severe injuries. Abrasive waterjets eject a mixture of water and abrasive materials that can be injected into body tissues, leading to a serious infection. Get immediate surgical attention after contact with high-pressure stream of fluid.</p>
 WARNING	Eye, ear, and respiratory protection, safety shoes, and other personal protective equipment are recommended. Failure to wear personal protective equipment can result in injuries or death.
 WARNING	Use a piece of cardboard or other solid material to find leaks when the pump is operating. Do not use hands, cloth, paper, or towels.
 WARNING	Do not repair a leak with high-pressure water in the system. Discharge all high-pressure water before working on this equipment.
 WARNING	Do not touch a hot surface. Fittings can get hot, especially when they are not properly tightened.
 CAUTION	Support all plumbing to prevent bending stress and fatigue from vibration. A disruption or crack in plumbing can cause injuries to people or damage to equipment.
	High-pressure water can cause eye injuries. Wear approved eye protection when operating or working near this equipment.
	<p>This waterjet system might exceed national and local codes for permitted noise levels.</p> <p>When this pump is running, the noise level is 80 to 85 dB(A). Noise level is related to factors such as water flow rate, pipe layout, and the acoustical characteristics of the building.</p> <p>Prolonged exposure to noise can cause permanent hearing loss. Wear approved ear protection and control exposure time when operating or working near this equipment.</p>
	Precision parts have sharp corners or edges. Wear protective gloves when handling parts.
	Some materials can produce airborne contaminants or suspended particles when cut. Wear approved respiratory protection.
	Do not operate the pump without the shaft access cover and all other safety devices in position. Do not remove guards while the pump is running.

	Follow all safety requirements and applicable safety laws and regulations.
	Coordinate preventive maintenance and repair activities with operations and safety staff.
	Examine and clean the pump regularly. Make repairs promptly.
	Use proper tools for maintenance procedures. Some tools are designed to make the procedure easier and to prevent damage to the pump.
	People who maintain and repair this equipment must know how to use standard hand tools.
	Before reassembling high-pressure or hydraulic parts, make sure that the parts have been wiped clean to remove dirt or other contaminants.
	Use clean hands when changing high-pressure parts such as high-pressure water seals.

Tips



- Keep the work area clean and free of fluid spills. Use catch basins under areas where water or hydraulic fluid can spill during maintenance or repair procedures.
- Keep accurate maintenance records.
- Remove all tools from the work area before starting the pump.
- Keep parts available so that they are ready when required.
- Follow local protocols for recycling or disposal of parts and materials. Refer to Recycling and end of product life on page 193.

Preventive maintenance schedule

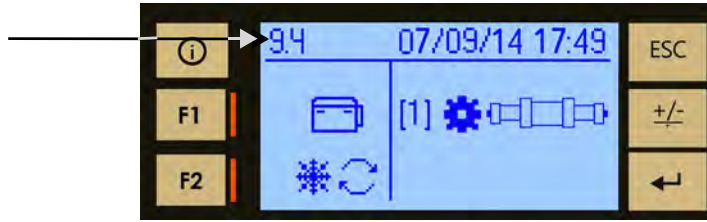
These maintenance intervals are general guidelines. The top left of the operator interface screen shows the total hours the pump has been in operation.



	Every shift	Every 40 hours	Every 500 hours	Every 1,000 hours	Every 1,500 hours	Every 3,000 hours
Electrical system						
Make sure that the emergency stop pushbutton works. Examine cords and plugs for deterioration or damage.	✓					
Low-pressure system						
Examine the pump for leaks or damage. Check the low-pressure water pressure gauges.	✓					
Measure the pressure in the water accumulator tank.			✓			
Replace the water filters. Test the low-pressure water TDS level.				✓		
Hydraulic system						
Examine the pump for leaks or damage. Check the hydraulic fluid indicator. Check the hydraulic fluid level. Check the hydraulic fluid quality.	✓					
Measure the hydraulic fluid temperature.		✓				
Replace the hydraulic filter.					✓	
Replace the hydraulic fluid.						✓

	Every shift	Every 500 hours	Every 1,000 hours	Every 2,000 hours	Every 3,000 hours	Every 6,000 hours	Every 12,000 hours
High-pressure water system							
Examine the pump for leaks or damage.	✓						
<p> These procedures require disassembling the intensifier. Detailed instructions about disassembling and reassembling the intensifier begin on page 110.</p> <p> To reduce downtime, Hypertherm recommends doing maintenance on both ends of the intensifier at the same time.</p>							
Repair the check valves. Repair the low-pressure poppets. Replace the high-pressure water seals, the hoops, and the high-pressure seal backups. Replace the hydraulic rod seals. Repair the high-pressure cylinders.		✓					
Replace the high-pressure poppet assemblies. Replace the low-pressure poppets and poppet springs.			✓				
Replace the check valves. Replace the low-pressure poppet baskets.				✓			
Replace the high-pressure cylinders. Replace the plunger bearings. Replace the indicator pin springs.					✓		
Replace the output adapters. Replace the seal housings. Replace the indicator pins.						✓	
Replace the spacer tubes.							✓
Service the hydraulic center section. The center section includes the pistons, plungers, hydraulic cylinder, high-pressure end caps, and proximity switches. Preventive maintenance on these parts requires special tools. Hypertherm Technical Service Associates are available to supply information about maintenance, repair, and diagnostic support.							✓
Examine the bleed-down valve for leaks or damage.	✓						
Service the bleed-down valve.			✓				
Replace the bleed-down valve body.					✓		

Tools

Some maintenance and repair procedures recommend or require special tools. This page is intended to help a user identify tools that could be unfamiliar or are known by other names.



Seal housing removal tool (included in the HyPrecision standard tool kit)



Open-ended wrench



Open-ended crowfoot wrench



Dental pick

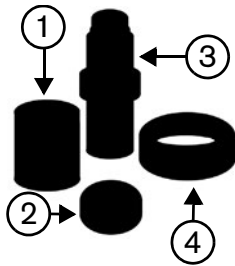

Seal installation tools (included in the HyPrecision standard tool kit)

1 Sleeve

3 Push tool

2 Spacer

4 Locator

Complete list of preventive maintenance kits, parts, tools, and materials

Kits

- 12084 HyPrecision standard tool kit
- 15566 HyPrecision basic standard spares kit

Parts

- 11743 Bleed-down valve flow reducer
- 14141 High-performance bleed-down valve body
- 11523 Check valve assembly
- 11520 Low-pressure poppet basket
- 11530 Output adapter
- 11522 High-pressure cylinder
- 11609 Seal housing
- 11608 Plunger bearing
- 11521 Spacer tube
- 12438 Suction strainer, 1-1/2 in.
- 11960 Suction strainer, 2-1/2 in.
- 14629 Filler-breather cap
- 11518 Indicator pin

Tools

- 13897 TDS meter
- SAE 5/8-inch open-ended wrench
- SAE 3/4-inch open-ended wrench
- SAE 13/16-inch open-ended wrench
- SAE 7/8-inch open-ended wrench
- Two SAE 1-inch open-ended wrenches
- SAE 1-1/16-inch open-ended wrench
- SAE 1-1/8-inch open-ended wrench
- SAE 9/16-inch crowfoot wrench or socket
- SAE 3/4-inch open-ended crowfoot wrench or socket
- SAE 13/16-inch open-ended crowfoot wrench or socket
- SAE 1-inch open-ended crowfoot wrench or socket
- SAE 1/8-inch hex wrench or hex-bit socket
- SAE 5/32-inch hex wrench or hex-bit socket
- Torque wrench
- Strap wrench or adjustable pliers
- Flat-blade screwdriver (for pumps with a water-modulating valve)
- Cross-tip screwdriver
- Two 8-32 × 2-inch (or longer) socket-head cap screws
- Rubber mallet
- Infrared thermometer
- Air pressure gauge (Schrader valve)
- Compressed air source
- Dental pick (recommended)

Materials

- 11210-30 30-micron lapping paper
- 11111 Blue Goop high-pressure antiseize lubricant
- 11448 AccuGoop food-grade high-pressure antiseize lubricant
- 11447 High-vacuum grease
- 11136 Silicone-based high-vacuum grease
- 13186 White lithium grease antiseize bolt lubricant
- 13969 Petroleum-based O-ring lubricant
- 11120 Blue 242 thread sealant
- Nonstick scouring pad
- Emery cloth
- Clean, deionized water or filtered water
- ISO viscosity grade (VG) 32 or 46 antiwear mineral or synthetic hydraulic fluid
- Clean, lint-free towel
- Isopropyl alcohol
- Masking tape
- Container for a water sample
- Container for used hydraulic fluid
- Hose or pipe for draining hydraulic fluid
- Clean funnel (recommended)
- Bucket or pail (recommended)

5 – Preventive maintenance

Every shift

Make sure that the emergency stop pushbutton works

 If the pump is configured to run remotely and has a motion system (robot or cutting table), the emergency circuits from the robot or cutting table can be wired in series with the local emergency stop circuit.

The EMERGENCY STOP pushbutton is available on the operation panel.

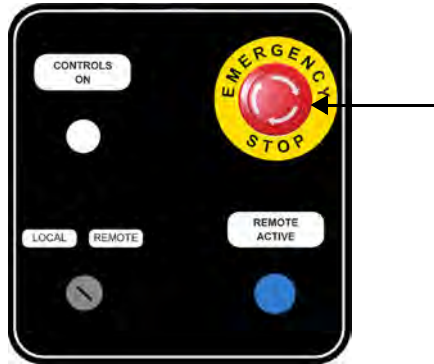



Do this task when the pump is running.

Press the EMERGENCY STOP pushbutton.

- The control circuit turns off, which causes the pump, primary motor, and intensifier to turn off.
- The bleed-down valve opens and discharges high-pressure water from the system.
- The CONTROLS ON button indicator light turns off.



Examine cords and plugs for deterioration or damage

 DANGER	People who maintain and repair this equipment can be injured or killed if hazardous energy is not properly controlled. Injuries can include burns, cuts, fractures, or electrocution. Turn off electrical power and relieve all water and hydraulic pressure from the pump before starting maintenance or repairs. Disconnect and lock out–tag out the electrical main before opening the electrical enclosure or doing maintenance or repair procedures.
	When replacing wiring, use only the same size, type, and color as the original wiring.
	Repair or replace parts identified in the preventive maintenance schedule or if the parts show signs of deterioration, corrosion, or damage.

Do this task when the pump is not running.

1. Examine electrical cords for kinks or damage to the insulation.
2. Examine electrical plugs and other electrical connectors for corrosion or damage.

Examine the pump for leaks or damage

 WARNING	Use a piece of cardboard or other solid material to find leaks when the pump is operating. Do not use hands, cloth, paper, or towels.
 CAUTION	Failure to correct the cause of a leak can result in damage to the fittings.
	Repair or replace parts identified in the preventive maintenance schedule or if the parts show signs of deterioration, corrosion, or damage.

Do this task when the pump is running and the system is pressurized.

1. Examine the pump for signs of hydraulic fluid leaks. Pay attention to these areas.
 - ❑ Hydraulic fluid tank access cover
 - ❑ Hydraulic connections
 - ❑ Valves
 - ❑ Top and bottom decks
2. Examine the low-pressure pipes and hoses for leaks.
3. Examine the high-pressure tubing for leaks.
4. Make sure that all of the fittings are tight.
5. Examine the weep holes and leak points at both of the high-pressure ends for leaks. Water seeping from a weep hole is a sign of a faulty part, a loose connection, or a damaged connection.

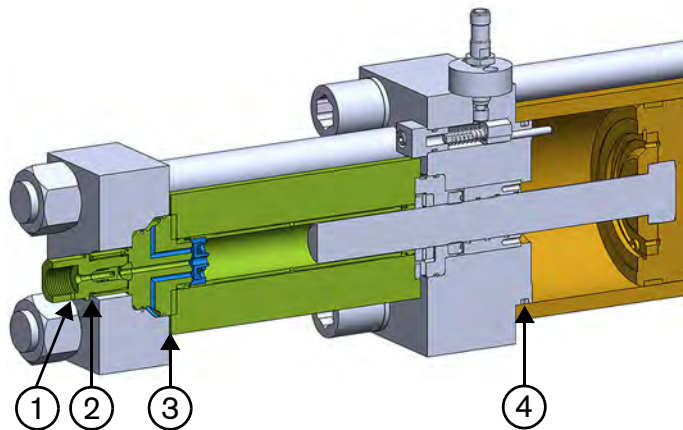

- | | |
|--------------------------------|----------------------------------|
| 1 Output adapter weep hole | 3 Static seal leak point |
| 2 High-pressure seat weep hole | 4 Dynamic seal housing weep hole |

If a leak is found, identify the source and repair the problem. Refer to the Troubleshooting section, which begins on page 153.



If a fitting is not tight, high-pressure water can cause the fitting to become hot.

5 – Preventive maintenance

Check the low-pressure water pressure gauges

The prefilter water pressure gauge shows the water pressure before the water goes through the filters. The postfilter water pressure gauge shows the water pressure after the water goes through the filters.

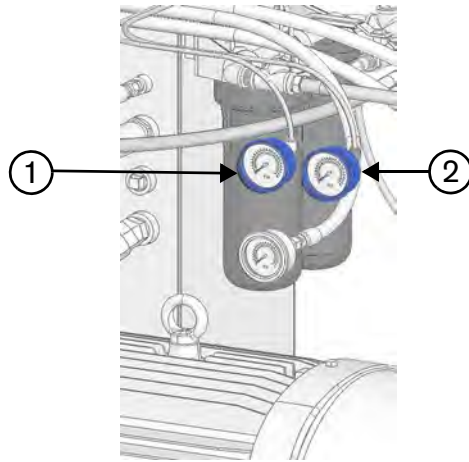

1 Prefilter water pressure gauge

2 Postfilter water pressure gauge

Do this task when the pump is running.

 The normal operating range is 3 bar to 8 bar or 276 kPa to 758 kPa (40 psi to 110 psi).

1. Look at the gauges.
2. Replace the water filters if the postfilter water pressure is lower than 3 bar or 276 kPa (40 psi).
3. Subtract the postfilter water pressure from the prefilter water pressure. Replace the water filters if the difference between the values on the pre- and postfilter water-pressure gauges is higher than 1 bar or 69 kPa (10 psi).

 Replace the water filters after every 1,000 hours of operation. Refer to page 85 for instructions.

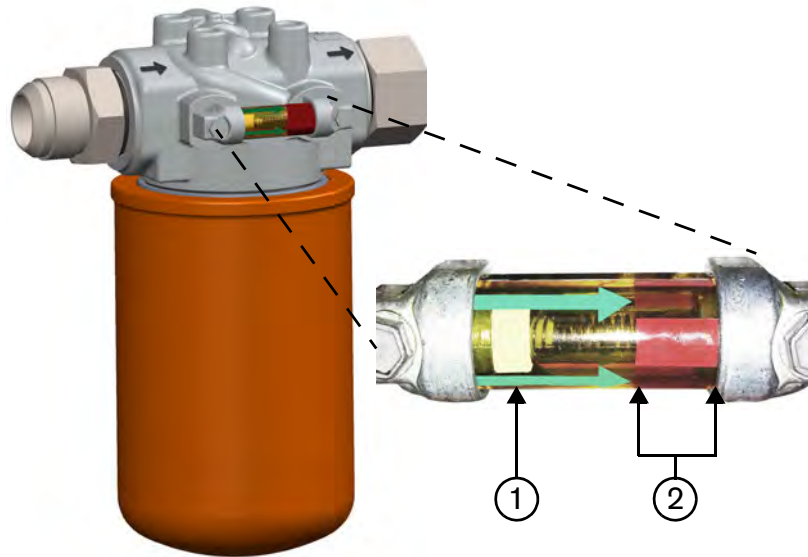
Check the hydraulic fluid indicator

1 White indicator

2 Red zone

 Replace the filter after every 1,500 hours of operation.

 Replace the filter when the white indicator stays in the red zone while the pump is running at operating temperature. Refer to page 92 for instructions.

5 – Preventive maintenance

Check the hydraulic fluid level

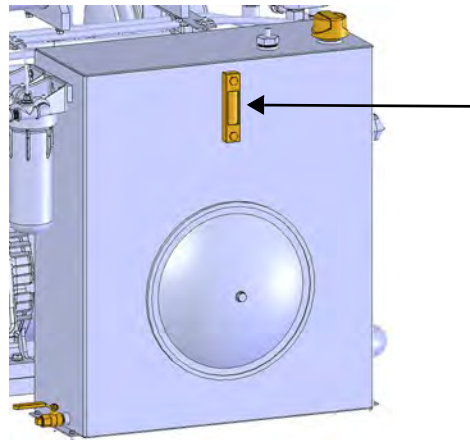

Sight gauge

Do this task when the pump is running.

1. Make sure that the hydraulic fluid level is at the top mark on the sight gauge.
2. Add hydraulic fluid if necessary. Refer to page 73 for instructions.

Add hydraulic fluid

The capacity of the hydraulic fluid tank is 151 L (40 gallons).

 For air-cooled pumps, increase the hydraulic fluid available by at least 19 liters (5 gallons) to fill the hoses and heat exchanger.

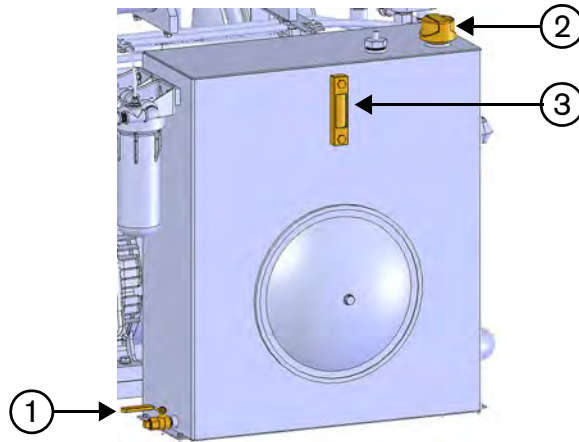

- 1 Drain valve lever
- 2 Filler-breather cap

3 Sight gauge



Required tools, materials, and parts

ISO viscosity grade (VG) 32 or 46 antiwear mineral or synthetic hydraulic fluid

Recommended materials

Clean funnel

Do this task when the pump is not running.

1. Make sure that the drain valve is closed.
2. Remove the filler-breather cap on top of the tank.
3. Fill the tank with hydraulic fluid until the fluid is at the top mark on the sight gauge.

	Do not overfill the hydraulic fluid tank.
---	---

4. Install the original filler-breather cap.

5 – Preventive maintenance

Check the hydraulic fluid quality

 Contact a hydraulic fluid supplier for a precise report on the hydraulic fluid quality.

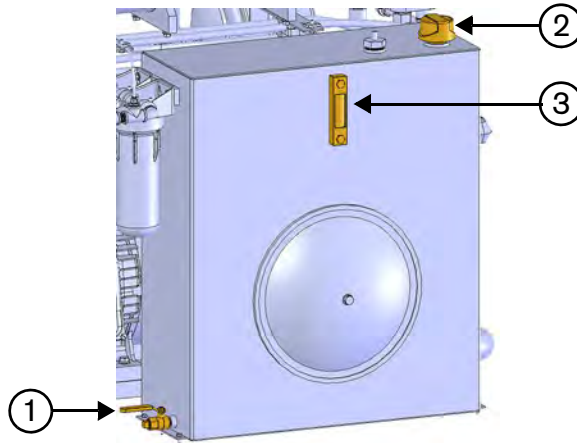

- 1 Drain valve lever
- 2 Filler-breather cap

3 Sight gauge

Do this task when the pump is not running.

1. Make sure that the drain valve is closed.
2. Look through the sight gauge to see the color of the hydraulic fluid. Good hydraulic fluid is almost clear.
3. Remove the filler-breather cap on top of the tank.
4. Smell the hydraulic fluid. Good hydraulic fluid has almost no odor.
5. Replace the hydraulic fluid in these situations.
 - If it is dark or milky in color
 - If it has a strong odor
 - After every 3,000 hours of operation

Refer to page 94 for instructions.

Examine the bleed-down valve for leaks or damage

Failure to correct the cause of a leak can result in damage to the fittings.

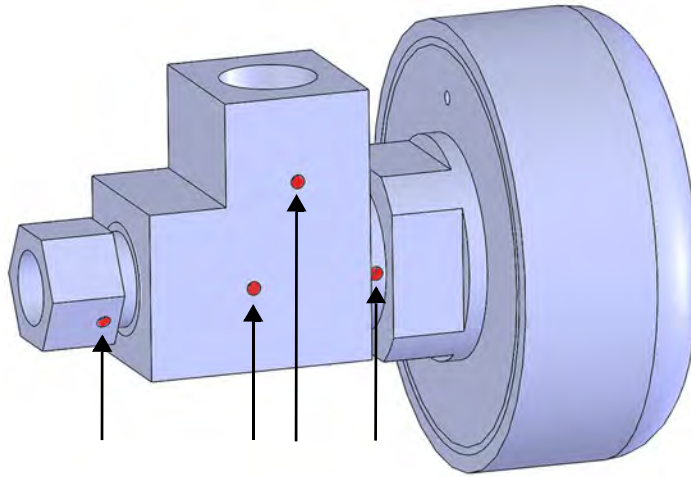

Weep holes

Do this task when the pump is running.

1. Remove the rear pump panel.
2. Examine the bleed-down valve for leaks. If a leak is found, identify the source and repair the problem. Refer to the Troubleshooting section, which begins on page 153.

5 – Preventive maintenance

Every 40 hours

Measure the hydraulic fluid temperature

Keep the hydraulic fluid temperature in the hydraulic fluid tank between 37.8°C (100°F) and 51.7°C (125°F). Hydraulic fluid that is too hot can deteriorate and cause the pump to fail. Hydraulic fluid that is too cool causes the pump to operate sluggishly.



Required tools, materials, and parts

Infrared thermometer

Do this task when the pump is running.

Point an infrared thermometer at the middle of the hydraulic fluid tank.



The optimal operating temperature is 40.6°C (105°F) to 46.1°C (115°F). If the temperature is outside of this range, adjust the hydraulic fluid temperature. Refer to page 77 for instructions.

Adjust the hydraulic fluid temperature**Required tools, materials, and parts**

- Flat-blade screwdriver (for pumps with an optional water-modulating valve)
- Infrared thermometer

Do this task when the pump is running.

Water-cooled with a heat exchanger

1. Open the valve on the cooling water line to increase the cooling water flow to the heat exchanger. Close the valve on the cooling water line to decrease the cooling water flow.
2. Wait approximately 5 minutes to let the hydraulic fluid temperature to stabilize.
3. Check the temperature.
4. Repeat this procedure until the temperature is in range.

Water-cooled with a water-modulating valve

1. Turn the screw on the top of the water-modulating valve 1/2 turn to the left (anticlockwise) to increase the temperature. Turn the screw on the top of the valve 1/2 turn to the right (clockwise) to lower the temperature.

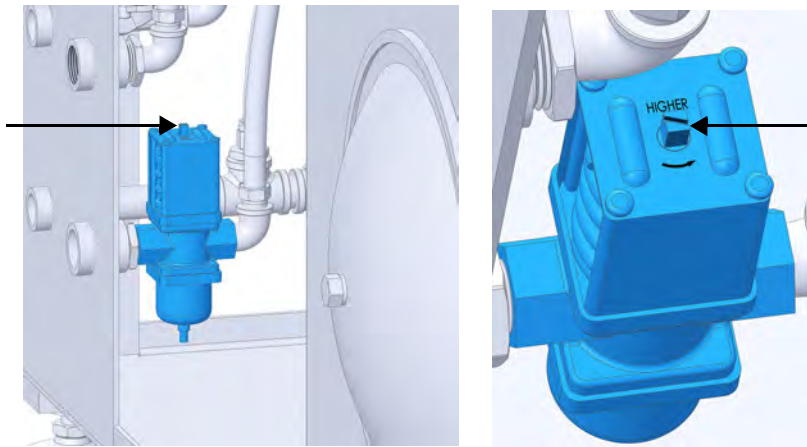

Adjusting screw

2. Wait approximately 5 minutes to let the hydraulic fluid temperature to stabilize.
3. Check the temperature.
4. Repeat this procedure until the temperature is in range.

Air-cooled

The temperature of an air-cooled pump is not adjustable. Refer to the Troubleshooting section, which begins on page 153 if the hydraulic fluid temperature is out of range.

5 – Preventive maintenance

Every 500 hours

Measure the pressure in the water accumulator tank

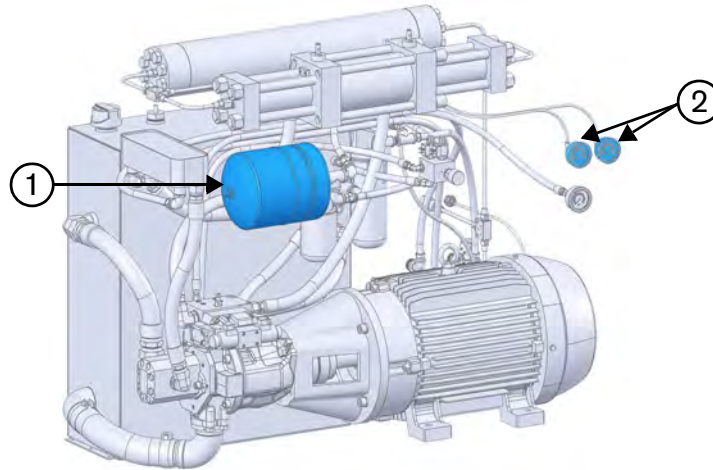

1 Accumulator tank

2 Water pressure gauges



Required tools, materials, and parts

Air pressure gauge (Schrader valve)

Compressed air source

Do this task when the pump is not running.

1. Turn OFF the water to the pump.
2. Open the valve to drain the water from the system. Make sure that the water pressure gauges show 0 bar or 0 kPa (0 psi).

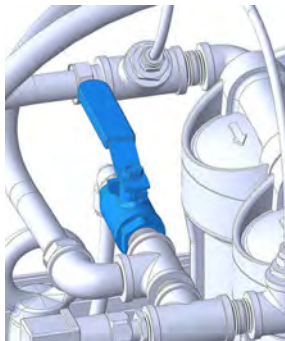

Water valve in open position

3. Remove the valve stem cap from the water accumulator.

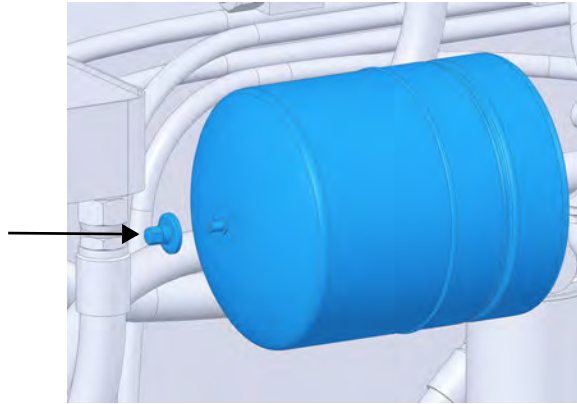

4. Use an air pressure gauge to measure the pressure in the water accumulator. The optimum air pressure is 2 bar or 207 kPa (30 psi).
To reduce the pressure, press the valve stem to release air from the accumulator. Add compressed air to increase the pressure.
5. Repeat this procedure until the pressure is 2 bar or 207 kPa (30 psi).
6. Install the original valve stem cap.
7. Close the water valve.





Water valve in closed position

5 – Preventive maintenance

Repair the check valves

Repair the low-pressure poppets

	Repair or replace parts identified in the preventive maintenance schedule or if the parts show signs of deterioration, corrosion, or damage.
	Put the parts on a clean, dry, oil-free surface.

Replace the low-pressure poppets after every 1,000 hours of operation.

Replace the check valve after every 2,000 hours of operation.

This procedure is for a moderately worn check valve. Severe wear requires replacement.

 To reduce downtime, Hypertherm recommends doing preventive maintenance on both ends of the intensifier at the same time.

 Refer to the Parts lists section, which begins on page 147, for part numbers and ordering information.

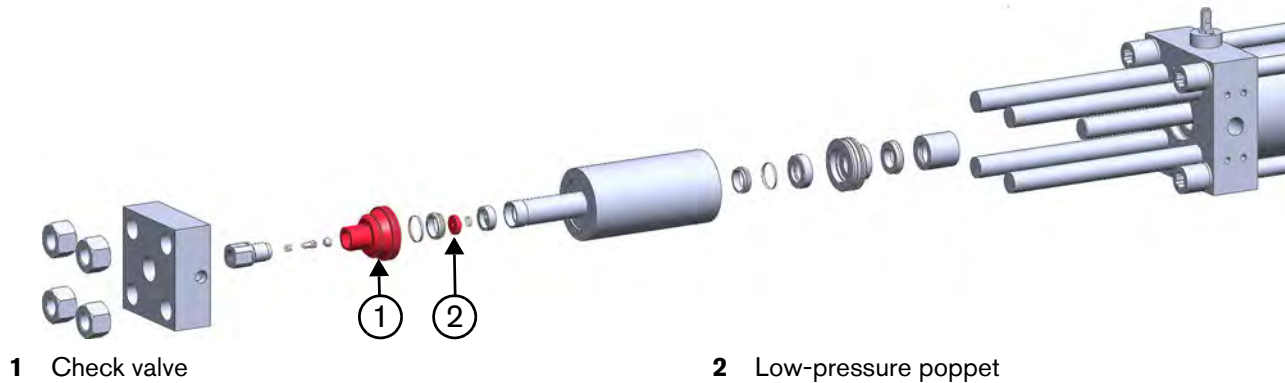

Required tools, materials, and parts

12-micron lapping paper (included in the HyPrecision standard tool kit)

15-micron lapping paper (included in the HyPrecision standard tool kit)

Granite surface plate (included in the HyPrecision standard tool kit)

Clean, lint-free towel

Isopropyl alcohol

Masking tape

1. Disassemble the intensifier to access the parts. Refer to page 104 for instructions.

2. Tape a sheet of lapping paper on a granite surface block. Make sure that the paper is smooth and flat.

 For best results, start with the 12-micron lapping paper and finish with the 15-micron lapping paper.

- Put the check valve or poppet face flat on the lapping paper and slide it back and forth. Apply light pressure.



Rocking the part or using too much pressure can damage the part face.

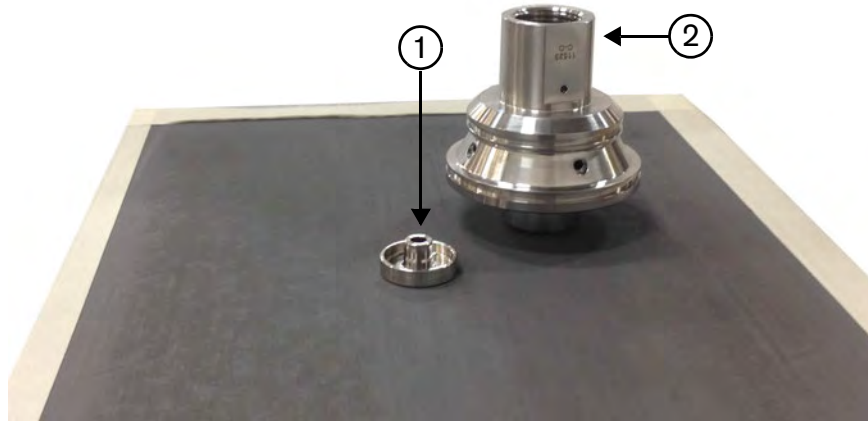

1 Low-pressure poppet

2 Check valve

- After each stroke, rotate the flat face of the part 45°.
- Repeat this procedure until the face is smooth and flat and has a nearly mirrored finish.
- Clean each part with a lint-free towel and isopropyl alcohol.



Do not use soap, detergent, or solvents.



- When all maintenance tasks are complete, reassemble the parts. Refer to page 111 for instructions.

5 – Preventive maintenance

Replace the high-pressure water seals, the hoops, and the high-pressure seal backups

Replace the hydraulic rod seals

Replace the check valve O-rings and seal housing O-ring and backup

	Repair or replace parts identified in the preventive maintenance schedule or if the parts show signs of deterioration, corrosion, or damage.
	Put the parts on a clean, dry, oil-free surface.

 To reduce downtime, Hypertherm recommends doing preventive maintenance on both ends of the intensifier at the same time.

 Refer to the Parts lists section, which begins on page 147, for part numbers and ordering information.

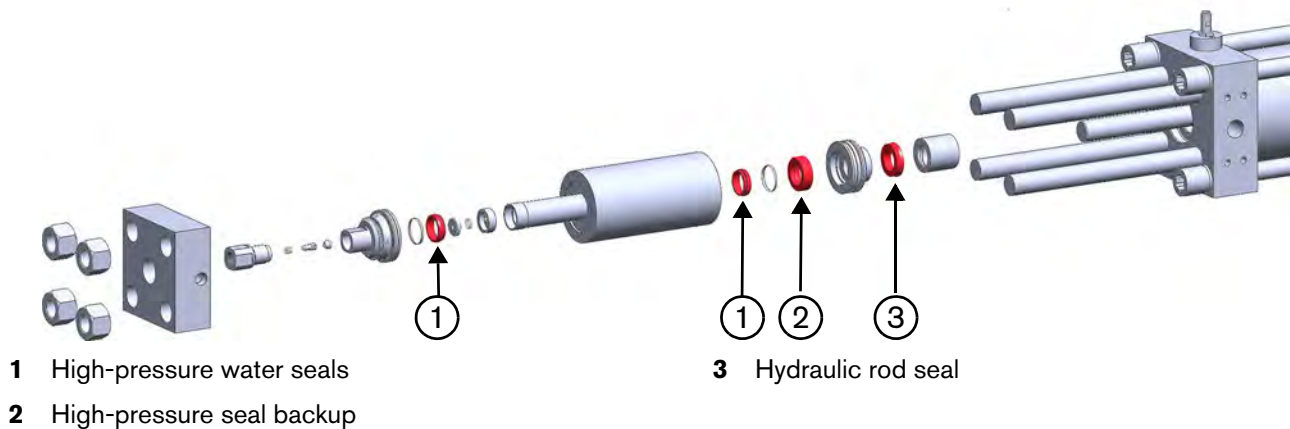



Required tools, materials, and parts

15563 HyPrecision premium high-pressure seal kit

1. Disassemble the intensifier to access the parts. Refer to page 104 for instructions.
2. Discard the used parts.
3. Install the new parts.
4. When all maintenance tasks are complete, reassemble the parts. Refer to page 111 for instructions.

Repair the high-pressure cylinders

	Repair or replace parts identified in the preventive maintenance schedule or if the parts show signs of deterioration, corrosion, or damage.
	Put the parts on a clean, dry, oil-free surface.

Replace the high-pressure cylinder after every 3,000 hours of operation.

 To reduce downtime, Hypertherm recommends doing preventive maintenance on both ends of the intensifier at the same time.

 Refer to the Parts lists section, which begins on page 147, for part numbers and ordering information.

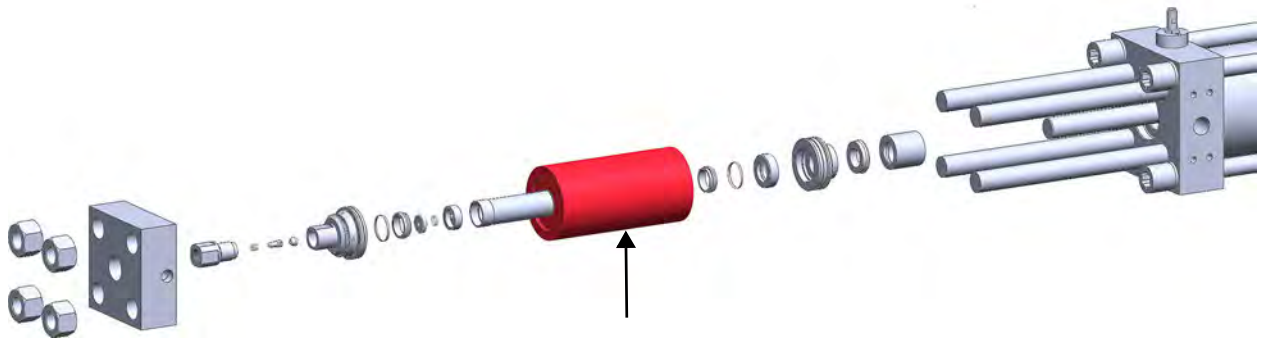

Required tools, materials, and parts

11210-30 30-micron lapping paper

Clean, lint-free towel

Nonstick scouring pad

Isopropyl alcohol

Emery cloth

1. Disassemble the intensifier to access the parts. Refer to page 104 for instructions.
2. Put the cylinder on a flat surface.
3. Examine the end of the cylinder. If the area outside of the bore is marked or pitted, rub the defects with an emery cloth and then a nonstick scouring pad.
4. Examine the edges of the cylinder bore. If the bore has rough edges or burrs, rub the defects with an emery cloth.

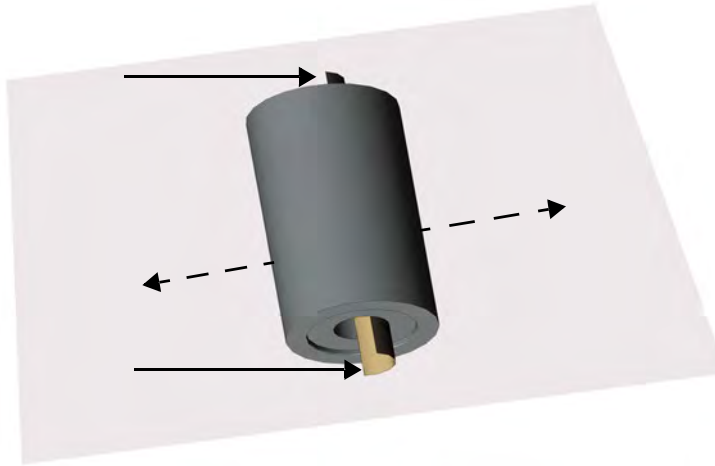

5 – Preventive maintenance

5. Cut the nonstick scouring pad in half. Put 1 half of the pad in each end of the cylinder. Put 1 thumb in each end of the cylinder on top of the pad and press down. Press evenly on the pad while rolling the cylinder forward and backward.



Nonstick scouring pad





6. Fold or cut the lapping paper to make 2 pieces, each approximately 3 cm (1-1/4 inches) wide by 8 cm (3-1/4 inches) long.
7. Put the lapping paper into the ends of the cylinder with the abrasive side touching the cylinder.
8. Repeat the rolling procedure with the lapping paper.
9. Clean the inside of the cylinder thoroughly with a lint-free towel and isopropyl alcohol.

 CAUTION	Debris left in the cylinder can cause the seals or the poppets to fail.
	Do not use soap, detergent, or solvents.

10. When all maintenance tasks are complete, reassemble the parts. Refer to page 111 for instructions.

Every 1,000 hours

Replace the water filters

 <p>CAUTION</p>	<p>Failure to correct the cause of a leak can result in damage to the fittings.</p>
	<p>Repair or replace parts identified in the preventive maintenance schedule or if the parts show signs of deterioration, corrosion, or damage.</p>
	<p>Put the parts on a clean, dry, oil-free surface.</p>
	<p>Replace both filters at the same time.</p>

Hypertherm HyPrecision 15, 30, and 50 pumps come with 2 water filters that remove contaminants from the cutting water.

 Refer to the Parts lists section, which begins on page 147, for part numbers and ordering information.

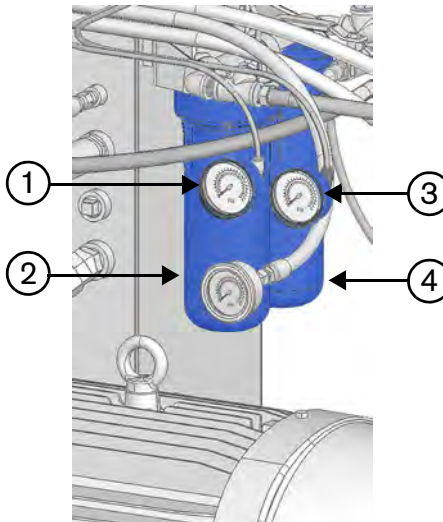

- | | |
|----------------------------------|-----------------------------------|
| 1 Prefilter water pressure gauge | 3 Postfilter water pressure gauge |
| 2 1-micron water filter | 4 0.45-micron water filter |

 **Required tools, materials, and parts**

- 11105 Water filter cartridge, 0.45 micron, 10 inch
- 11106 Water filter cartridge, 1.0 micron, 10 inch
- Water filter wrench (included in the HyPrecision standard tool kit)

Recommended materials

- Bucket or pail

5 – Preventive maintenance

Do this task when the pump is not running.

1. Turn OFF the water to the pump.
2. Open the valve to drain the water from the system. Make sure that the water pressure gauges show 0 bar or 0 kPa (0 psi).

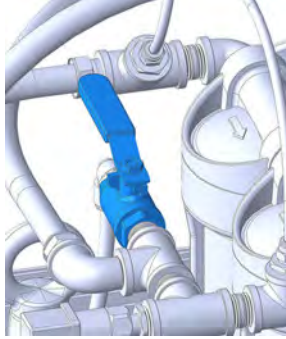

Water valve in open position

3. Use a water filter wrench to loosen each of the filter housings.
4. Pour the water out of the housings.
5. Remove the filter cartridges from the filter housings and discard them.
6. Put a new 0.45-micron cartridge in the housing with the plug at the bottom and the gray rubber gasket at the top.
7. Put a new filter cartridge in the 1-micron filter housing.

 The 1-micron filter does not have a designated top or bottom.



8. Install the housing with the 0.45-micron filter cartridge in the housing closer to the rear of the pump.
9. Install the housing with the 1-micron filter cartridge in the housing closer to the front of the pump.
10. Use a water filter wrench to tighten each of the filter housings.

11. Close the water valve.
12. Turn ON water to the pump.
13. Turn ON the pump in cooling mode.
14. Press the filter purge buttons until water comes out from under each button.

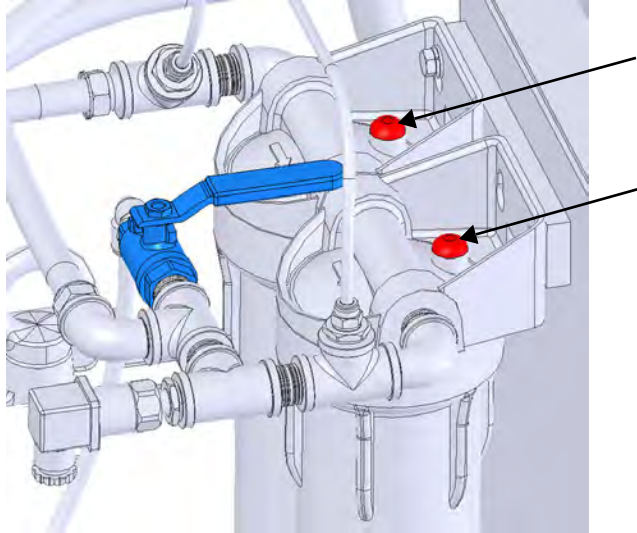

15. Put the pump in running mode.
16. Make sure that the difference between the values on the pre- and post-filter water-pressure gauges is lower than 0.7 bar or 69 kPa (10 psi).
17. Look for leaks. If a leak is found, identify the source and repair the problem. Refer to the Troubleshooting section, which begins on page 153.

5 – Preventive maintenance

Test the low-pressure water TDS level

Some TDS meters might require calibration before use. For best results, calibrate the meter at 25.0°C (77°F). Refer to the instructions supplied with the TDS meter.

If multiple readings are taken, turn the meter off and on for each reading.



Refer to the Parts lists section, which begins on page 147, for part numbers and ordering information.



Required tools, materials, and parts

13897 TDS meter

Container for the water sample

Clean, deionized water or filtered water

Do this task when the pump is running in cooling mode.

1. Open the valve to drain the water from the system. Make sure that the water pressure gauges show 0 bar or 0 kPa (0 psi).

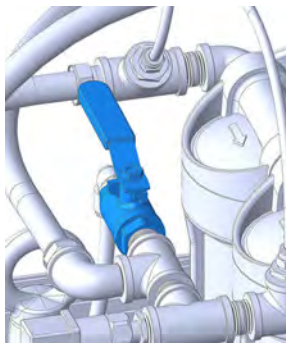

Water valve in open position

2. Let the water run for 30 seconds.
3. Take a sample from the wastewater outlet.



If the wastewater outlet can not be accessed, take a sample of the utility water going to the pump.

4. Put the TDS meter in the water sample up to the maximum immersion level (5 cm/2 inches). Tap the meter lightly to release air bubbles.





The meter is not waterproof. Do not submerge the unit in water.

5. Wait approximately 20 seconds for the reading to become stable.
6. Compare the reading to the TDS table on page 181 in the Installation section of this manual.
7. Rinse the meter in clean, deionized water or filtered water after use.

5 – Preventive maintenance

Replace the high-pressure poppet assemblies

Replace the low-pressure poppets and poppet springs

	Repair or replace parts identified in the preventive maintenance schedule or if the parts show signs of deterioration, corrosion, or damage.
	Put the parts on a clean, dry, oil-free surface.

 To reduce downtime, Hypertherm recommends doing preventive maintenance on both ends of the intensifier at the same time.

 Refer to the Parts lists section, which begins on page 147, for part numbers and ordering information.

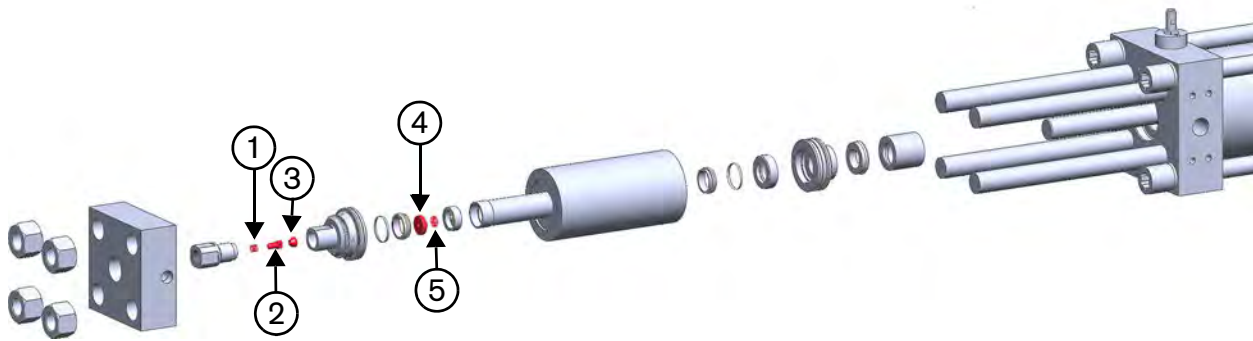

- 1 High-pressure poppet spring
- 2 High-pressure poppet
- 3 High-pressure seat





- 4 Low-pressure poppet
- 5 Low-pressure poppet spring

Required tools, materials, and parts

15565 HyPrecision basic poppet repair kit

1. Disassemble the intensifier to access the parts. Refer to page 104 for instructions.
2. Discard the used parts.
3. Install the new parts.
4. When all maintenance tasks are complete, reassemble the parts. Refer to page 111 for instructions.

Repair the bleed-down valve

 CAUTION	Failure to correct the cause of a leak can result in damage to the fittings.
 CAUTION	Overtightening a fitting can cause it to fail. Use 2 wrenches when loosening or tightening a high-pressure connection. Using only 1 wrench can increase bending stress to the parts and cause damage or premature failure.
	Repair or replace parts identified in the preventive maintenance schedule or if the parts show signs of deterioration, corrosion, or damage.
	Put the parts on a clean, dry, oil-free surface.

Replace the bleed-down valve body after every 3,000 hours of operation.

Replace this part if water leaks from the wastewater outlet or from the weep holes while the pump is running.

 Refer to the Parts lists section, which begins on page 147, for part numbers and ordering information.

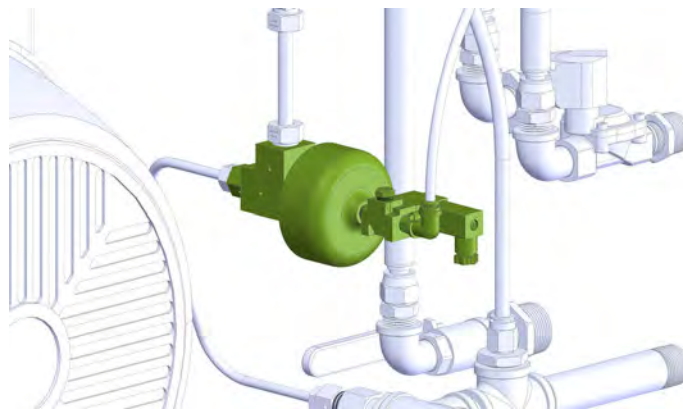

 **Required tools, materials, and parts**



- 11328 On/off valve and bleed-down valve repair kit
- 11743 Bleed-down valve flow reducer

Do this task when the pump is not running.

1. Disassemble the bleed-down valve. Refer to page 131 for instructions.
2. Discard the used parts.
3. Install the new parts.
4. When all maintenance tasks are complete, reassemble the parts. Refer to page 133 for instructions.

Every 1,500 hours

Replace the hydraulic filter

 CAUTION	Failure to correct the cause of a leak can result in damage to the fittings.
	Follow local regulations when disposing of used fluids and filters.
	Put the parts on a clean, dry, oil-free surface.

 Refer to the Parts lists section, which begins on page 147, for part numbers and ordering information.

 The capacity of the hydraulic fluid tank is 151 L (40 gallons).

Required tools, materials, and parts

16025 Hydraulic filter

ISO viscosity grade (VG) 32 or 46 antiwear mineral or synthetic hydraulic fluid

Strap wrench



Do this task when the pump is not running.

1. Remove the filter from the filter head.
2. Put clean hydraulic fluid on the gasket on the new filter.
3. Twist the filter onto the filter head.
4. Tighten the filter with a strap wrench.
5. Turn ON the pump in cooling mode.
6. Look for leaks. If a leak is found, identify the source and repair the problem. Refer to the Troubleshooting section, which begins on page 153.
7. Check the hydraulic fluid level. Add hydraulic fluid if necessary. Refer to page 73 for instructions.

Every 2,000 hours

Replace the check valves

Replace the low-pressure poppet baskets

	Repair or replace parts identified in the preventive maintenance schedule or if the parts show signs of deterioration, corrosion, or damage.
	Put the parts on a clean, dry, oil-free surface.

Install new high-pressure water seals when the check valve is replaced.

 To reduce downtime, Hypertherm recommends doing preventive maintenance on both ends of the intensifier at the same time.

 Refer to the Parts lists section, which begins on page 147, for part numbers and ordering information.

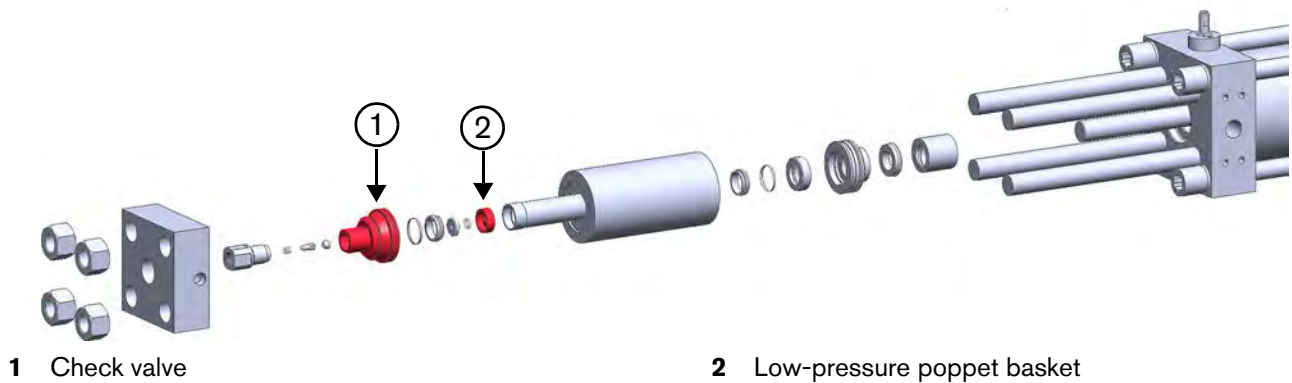

 **Required tools, materials, and parts**



- 11520 Low-pressure poppet basket
- 11523 Check valve assembly

1. Disassemble the intensifier to access the parts. Refer to page 104 for instructions.
2. Discard the used parts.
3. Install the new parts.
4. When all maintenance tasks are complete, reassemble the parts. Refer to page 111 for instructions.

5 – Preventive maintenance

Every 3,000 hours

Replace the hydraulic fluid

	Follow local regulations when disposing of used fluids and filters.
	Put the parts on a clean, dry, oil-free surface.

Install a new hydraulic filter and filler-breather cap when the hydraulic fluid is replaced.

 Refer to the Parts lists section, which begins on page 147, for part numbers and ordering information.

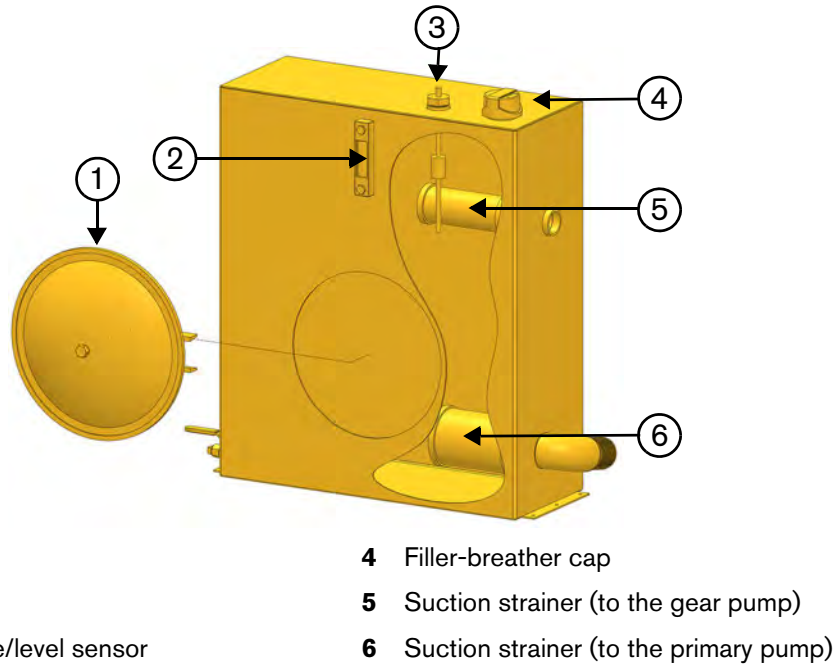

Required tools, materials, and parts

12438 Suction strainer, 1-1/2 inch

11960 Suction strainer, 2-1/2 inch

14629 Filler-breather cap

16025 Hydraulic filter

ISO viscosity grade (VG) 32 or 46 antiwear mineral or synthetic hydraulic fluid

Clean, lint-free towel

Isopropyl alcohol

Standard 9/16-inch crowfoot wrench or socket (drain valve plug)

Standard 3/4-inch crowfoot wrench or socket (access cover)

Torque wrench

Strap wrench or adjustable pliers

Hose or pipe for draining hydraulic fluid

Container for used hydraulic fluid

Recommended materials

Clean funnel

Do this task when the pump is not running.

1. Remove the drain valve plug.
2. Open the valve to drain the hydraulic fluid.

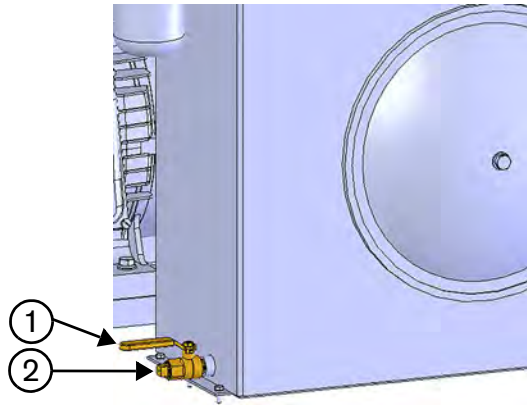

1 Drain valve lever

2 Drain valve plug

 Use a hose or a pipe to direct the hydraulic fluid into a container.

5 – Preventive maintenance

3. Disconnect the lower ends of these hydraulic hoses to drain them.

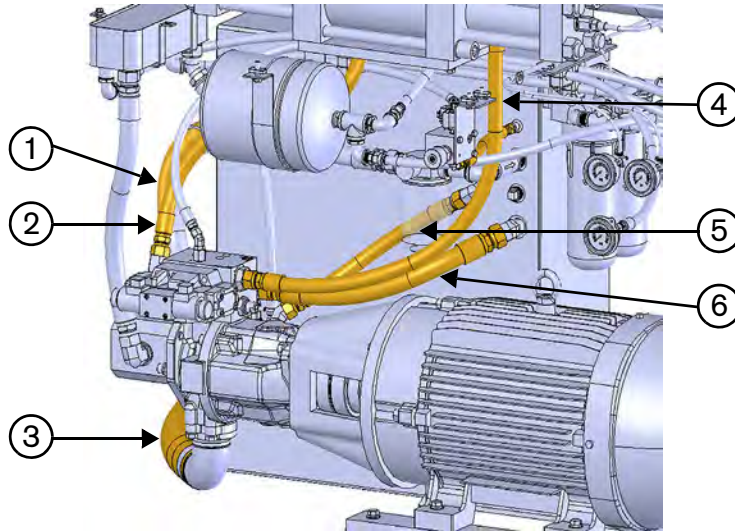

- | | |
|---|---|
| 1 Gear pump suction line | 4 From the primary hydraulic manifold to the intensifier (right) |
| 2 From the primary hydraulic manifold to the intensifier (left) | 5 Case drain hose |
| 3 Primary pump suction | 6 From the primary hydraulic manifold to the hydraulic fluid tank |



4. Install a new hydraulic filter. Refer to page 92 for instructions.

5. Remove the access cover on the tank.

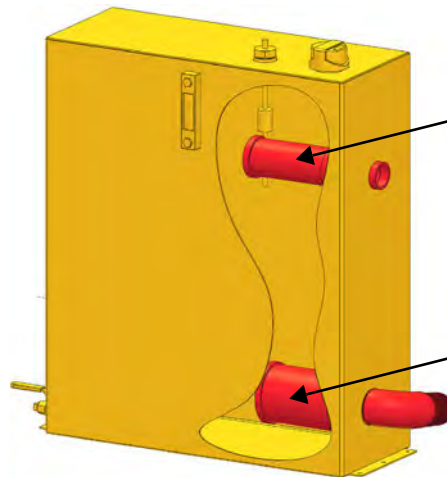
6. Use a strap wrench or adjustable pliers to remove the suction strainers inside the tank.



- Clean the inside of the tank with a lint-free towel and isopropyl alcohol. Make sure that no debris remains on the bottom.

 CAUTION	Make sure that all towels are removed from the tank before it is filled.
	Do not use soap, detergent, or solvents.

- Install new suction strainers.

 The suction strainer should be hand tightened and then turned 90° more.

- Reconnect the hydraulic hoses.

 Refer to the fittings torque tables on page 173.

- Close the drain valve.

- Install the original drain valve plug.

- Replace the access cover on the tank. Torque the nut to 27 N·m (20 lbf·ft).

- Remove and discard the used filler-breather cap.

- Fill the tank with hydraulic fluid. Make sure that the hydraulic fluid level is at the top mark on the sight gauge.

	Do not overfill the hydraulic fluid tank.
---	---

- Install the new filler-breather cap.

- Turn ON the pump in cooling mode. Let it run for 15 to 20 minutes.

- Look for leaks. If a leak is found, identify the source and repair the problem. Refer to the Troubleshooting section, which begins on page 153.

- As the hydraulic fluid circulates through the system, it could be necessary to add fluid. Fill the tank with hydraulic fluid until the fluid is at the top mark on the sight gauge.

Repeat this process as needed.

- Run the pump in pierce-pressure mode for 15 to 20 minutes.



If the pump is noisy, there could be air in the hydraulic fluid. Refer to the Troubleshooting section, which begins on page 153.

5 – Preventive maintenance

Replace the high-pressure cylinders

Replace the plunger bearings

Replace the indicator pin springs

	Repair or replace parts identified in the preventive maintenance schedule or if the parts show signs of deterioration, corrosion, or damage.
	Put the parts on a clean, dry, oil-free surface.

 To reduce downtime, Hypertherm recommends doing preventive maintenance on both ends of the intensifier at the same time.

 Refer to the Parts lists section, which begins on page 147, for part numbers and ordering information.

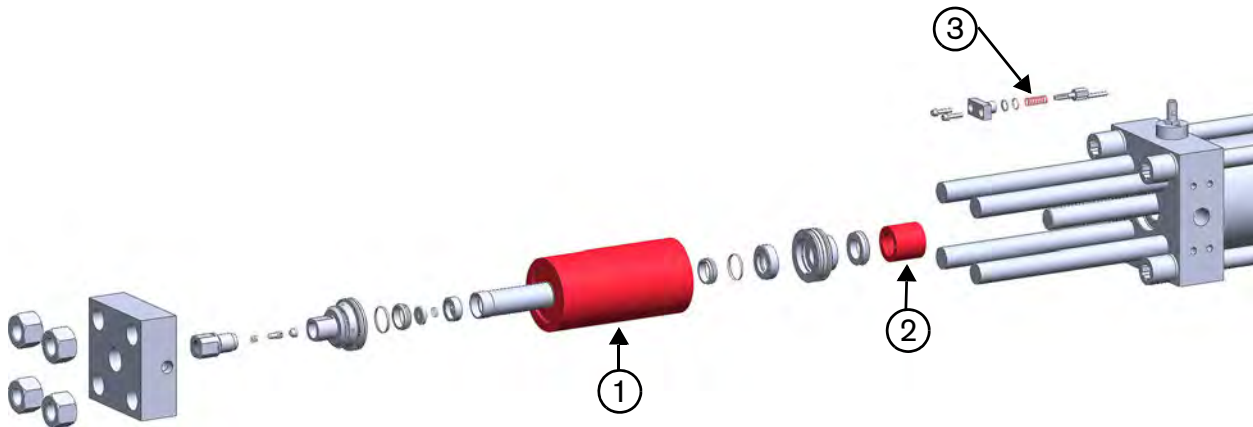

1 High-pressure cylinder

2 Plunger bearing

3 Indicator pin spring

Required tools, materials, and parts





11522 High-pressure cylinder

11608 Plunger bearing

11669 Indicator pin spring

1. Disassemble the intensifier to access the parts. Refer to page 104 for instructions.
2. Discard the used parts.
3. Install the new parts.
4. When all maintenance tasks are complete, reassemble the parts. Refer to page 111 for instructions.

Replace the bleed-down valve body

 CAUTION	Failure to correct the cause of a leak can result in damage to the fittings.
 CAUTION	Overtightening a fitting can cause it to fail. Use 2 wrenches when loosening or tightening a high-pressure connection. Using only 1 wrench can increase bending stress to the parts and cause damage or premature failure.
	Repair or replace parts identified in the preventive maintenance schedule or if the parts show signs of deterioration, corrosion, or damage.
	Put the parts on a clean, dry, oil-free surface.

 Replace this part if water leaks from the wastewater outlet or from the weep holes while the pump is running.

1. Disassemble the bleed-down valve. Refer to page 128 for instructions.
2. Discard the used parts.
3. Install the bleed-down valve body, output adapter, flow reducer, seat, needle, needle guide, and seal.
4. When all maintenance tasks are complete, reassemble the parts.



5 – Preventive maintenance

Every 6,000 hours

Replace the output adapters

Replace the seal housings

Replace the indicator pins

	Repair or replace parts identified in the preventive maintenance schedule or if the parts show signs of deterioration, corrosion, or damage.
	Put the parts on a clean, dry, oil-free surface.

 To reduce downtime, Hypertherm recommends doing preventive maintenance on both ends of the intensifier at the same time.

 Refer to the Parts lists section, which begins on page 147, for part numbers and ordering information.

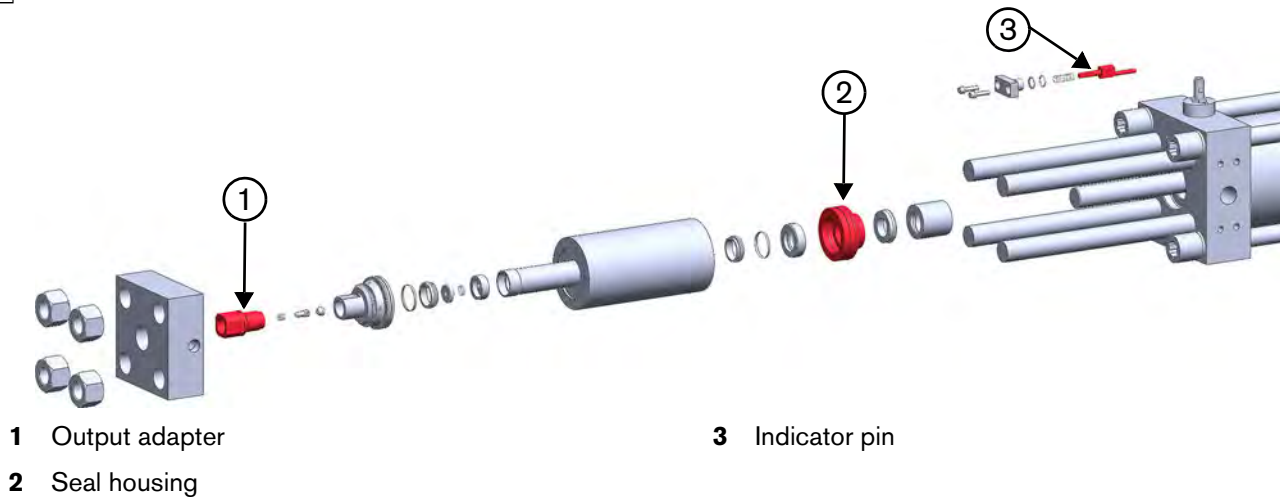



Required tools, materials, and parts

- 11530 Output adapter
- 11609 Seal housing
- 11518 Indicator pin
- 1-inch open-ended wrench

1. Disassemble the intensifier to access the parts. Refer to page 104 for instructions.
2. Discard the used parts.
3. Install the new parts.
4. When all maintenance tasks are complete, reassemble the parts. Refer to page 111 for instructions.

Every 12,000 hours

Replace the spacer tubes

	Repair or replace parts identified in the preventive maintenance schedule or if the parts show signs of deterioration, corrosion, or damage.
	Put the parts on a clean, dry, oil-free surface.

 To reduce downtime, Hypertherm recommends doing preventive maintenance on both ends of the intensifier at the same time.

 Refer to the Parts lists section, which begins on page 147, for part numbers and ordering information.

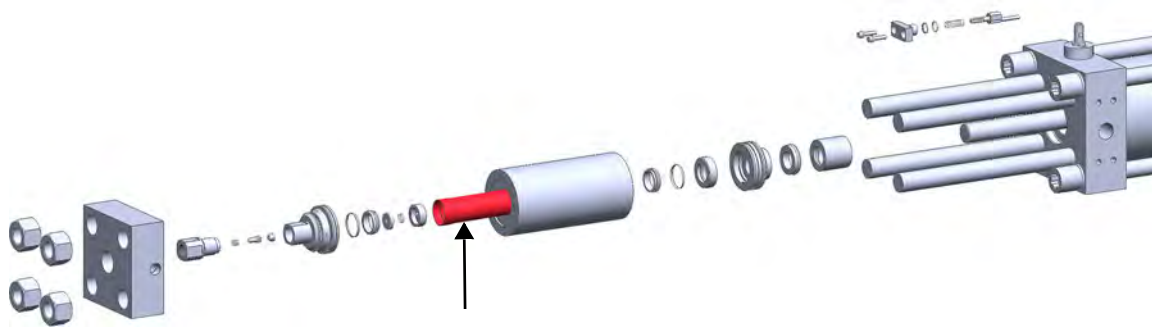

 **Required tools, materials, and parts**

11521 Spacer tube

1. Disassemble the intensifier to access the parts. Refer to page 104 for instructions.
2. Discard the used spacer tube.
3. Install a new spacer tube.
4. When all maintenance tasks are complete, reassemble the parts. Refer to page 111 for instructions.



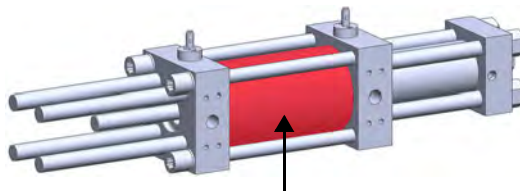

Service the hydraulic center section





The hydraulic center section includes the pistons, plungers, hydraulic cylinder, hydraulic end caps, low-pressure seals, and proximity switches.

Preventive maintenance on these parts requires special tools. Hypertherm Technical Service Associates are available to supply information about maintenance, repair, and diagnostic support.

Service the intensifier

 CAUTION	Failure to correct the cause of a leak can result in damage to the fittings.
 CAUTION	Overtightening a fitting can cause it to fail. Use 2 wrenches when loosening or tightening a high-pressure connection. Using only 1 wrench can increase bending stress to the parts and cause damage or premature failure.
	Repair or replace parts identified in the preventive maintenance schedule or if the parts show signs of deterioration, corrosion, or damage.
	Put the parts on a clean, dry, oil-free surface.

 Consider doing preventive maintenance on both high-pressure ends to reduce unplanned downtime.

 Refer to the Parts lists section, which begins on page 147, for part numbers and ordering information.

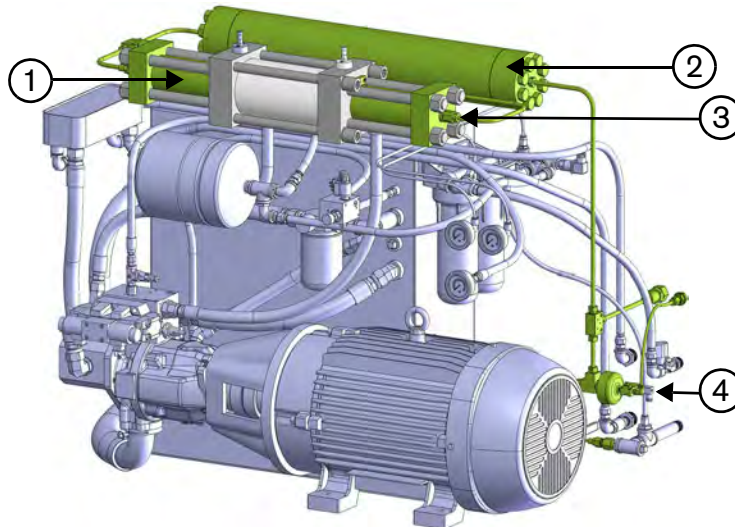

1 High-pressure ends

2 Attenuator

3 High-pressure water fitting

4 Bleed-down valve

Required tools, materials, and parts

13/16-inch open-ended wrench (high-pressure water fitting)

7/8-inch open-ended wrench (low-pressure water fitting)

1-inch open-ended wrench (output adapter)

1-1/6-inch open-ended wrench (high-pressure water fitting)



Do not use an adjustable wrench on high-pressure fittings.

1. Turn OFF the pump.
2. Turn OFF power from the primary utility source. Use standard lock out–tag out procedures.
3. Open the valve to drain the water from the system. Make sure that the water pressure gauges show 0 bar or 0 kPa (0 psi).

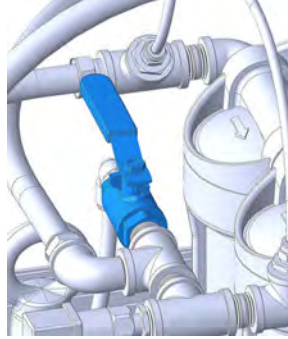

Water valve in open position

4. Disconnect the high-pressure tubing from the intensifier.
5. Disconnect the hose from the low-pressure water fitting on the high-pressure end cap.

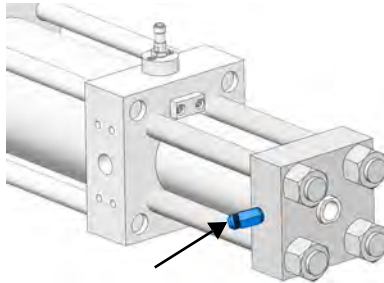

6. Disconnect the compressed air line from the bleed-down valve.

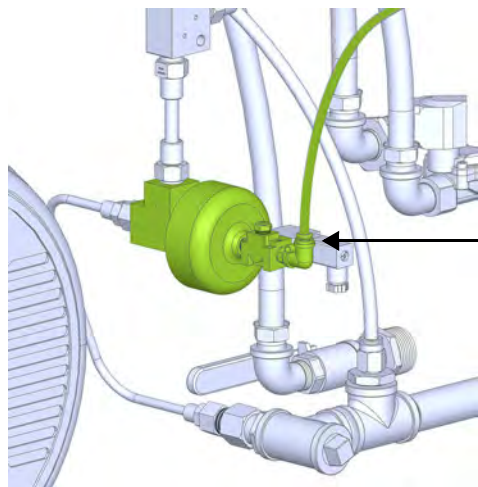

5 – Preventive maintenance

Disassemble the intensifier

Preventive maintenance on the intensifier involves accessing various assemblies at specified intervals.

Remove the output adapter and high-pressure poppet assembly

Replace these parts	After this many hours of operation
High-pressure poppet assemblies	1,000
Output adapters	6,000

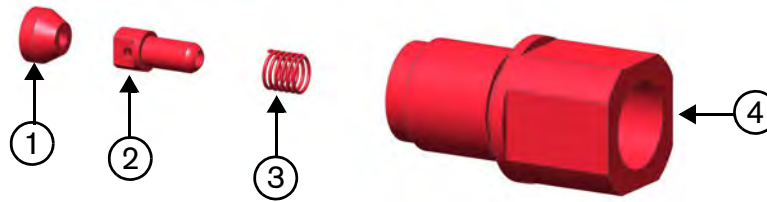

1 High-pressure poppet seat

2 High-pressure poppet

3 High-pressure poppet spring

4 Output adapter

Required tools, materials, and parts

Clean, lint-free towel

Isopropyl alcohol

Two 1-inch open-ended wrenches

6-inch cotton-tipped applicators (included in the HyPrecision standard tool kit)

1. Use an open-ended wrench to loosen the output adapter.
2. Remove the output adapter from the check valve.
3. Use a cotton-tipped applicator to guide the poppet seat out of the check valve. Tap the output adapter gently on a wooden or other soft surface to eject the spring and the poppet from the output adapter.
4. Clean each part with a lint-free towel and isopropyl alcohol.



Do not use soap, detergent, or solvents.

5. Examine all parts for deterioration, corrosion, or damage.

 The high-pressure seat can cause cracks, erosion marks, or indents in the output adapter.

6. Clean and examine parts that will be replaced to identify wear patterns or damage that can signify other problems.

 If any of the poppet parts are damaged, replace all 3.

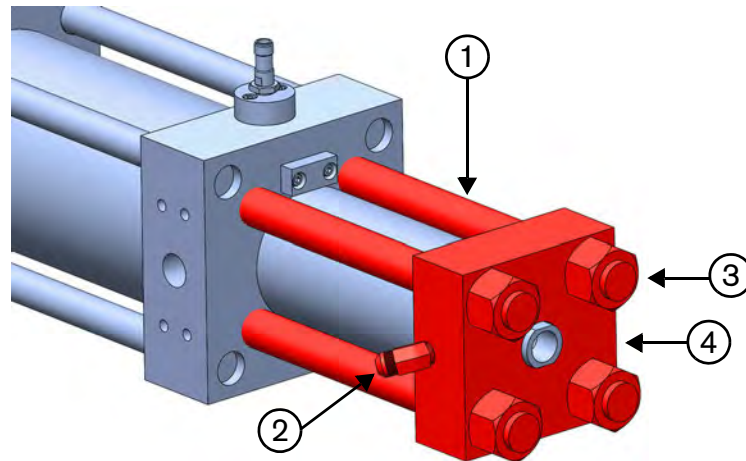
Remove the high-pressure end cap

- | | |
|--|---|
| <p>1 Studs</p> <p>2 Low-pressure water fitting</p> | <p>3 High-pressure end cap</p> <p>4 Stud nuts</p> |
|--|---|

**Required tools, materials, and parts**

Clean, lint-free towel

Isopropyl alcohol

13/16-inch open-ended wrench (high-pressure water fitting)

7/8-inch open-ended wrench (low-pressure water fitting)

Square drive socket, 1-1/2 inch × 3/4 inch (stud nuts) (included in the HyPrecision standard tool kit)

1. Disconnect the low-pressure water line.
2. Disconnect the high-pressure water line.
3. Remove the stud nuts.
4. Pull the end cap off.
5. Clean each part with a lint-free towel and isopropyl alcohol.



Do not use soap, detergent, or solvents.

6. Examine all parts for deterioration, corrosion, or damage.
7. Clean and examine parts that will be replaced to identify wear patterns or damage that can signify other problems.

5 – Preventive maintenance

Remove the high-pressure cylinder assembly and check valve

Repair these parts	After this many hours of operation
Check valves Low-pressure poppets High-pressure cylinders	500
Replace these parts	After this many hours of operation
High-pressure water seals	500
Check valves Low-pressure poppets	2,000
Low-pressure poppet baskets High-pressure cylinders	3,000
Spacer tubes	12,000

 Install a new plunger bearing every time the high-pressure cylinder is replaced.

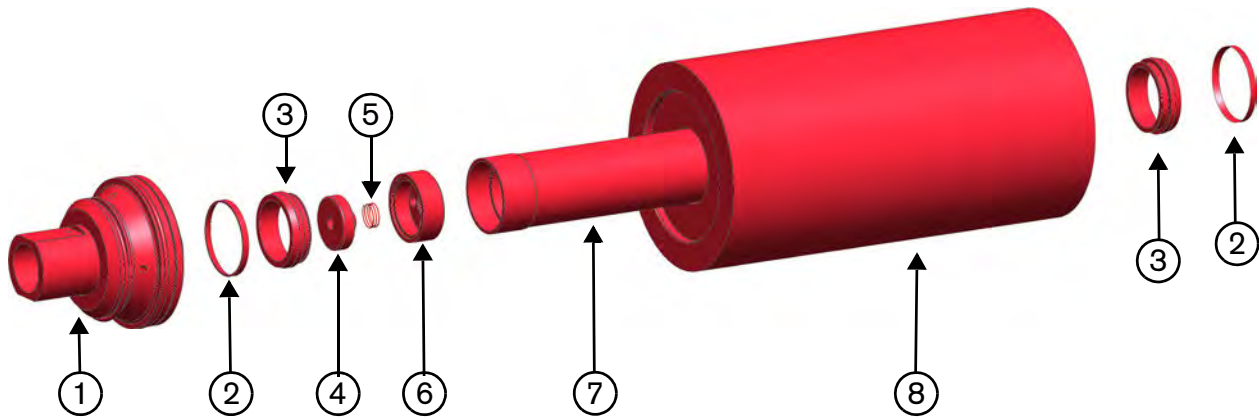

- | | |
|-----------------------------|------------------------------|
| 1 Check valve | 5 Low-pressure poppet spring |
| 2 High-pressure hoops | 6 Low-pressure poppet basket |
| 3 High-pressure water seals | 7 Spacer tube |
| 4 Low-pressure poppet | 8 High-pressure cylinder |

Required tools, materials, and parts

- Clean, lint-free towel
- Isopropyl alcohol
- Seal installation tools (included in the HyPrecision standard tool kit)
- Rubber mallet

1. Remove the high-pressure cylinder and the check valve from the plunger.

2. Remove the check valve by rolling the cylinder and tapping the check valve with a rubber mallet. Tap at an angle away from the cylinder.
3. Tilt the cylinder so that the low-pressure poppet comes out.
4. Put the cylinder on the seal-locating ring.
5. Put the stepped end of the push tool against the seal and tap on the end of the push tool with a rubber mallet to push the bottom seal and hoop out of the high-pressure cylinder.
6. Turn the cylinder over and put it on the locating ring.



Prevent the spacer tube from sliding out when the cylinder is turned over.

7. Position the nonstepped end of the push tool against the spacer tube and tap on the end of the push tool with a rubber mallet to push the remaining seal and hoop out of the high-pressure cylinder.
8. Slide the spacer tube out of the cylinder.
9. Disassemble all of the parts.
10. Clean each part with a lint-free towel and isopropyl alcohol.



Do not use soap, detergent, or solvents.

11. Examine all parts for deterioration, corrosion, or damage. Examine the check valve and low-pressure poppet faces for cracks or erosion marks. If damage is found, repair or replace the part.



Refer to page 80 for repair instructions. Refer to page 93 for replacement instructions.

12. Clean and examine parts that will be replaced to identify wear patterns or damage that can signify other problems.
13. Replace the high-pressure cylinder if it is chipped or cracked.

5 – Preventive maintenance

Remove the seal housing assembly and plunger bearing

Replace these parts	After this many hours of operation
High-pressure seal backups O-rings Hydraulic rod seals	500
Plunger bearings	3,000
Seal housings	6,000

Install a new plunger bearing every time the high-pressure cylinder is replaced.

 Remove the proximity switch from the end cap to make this step easier.

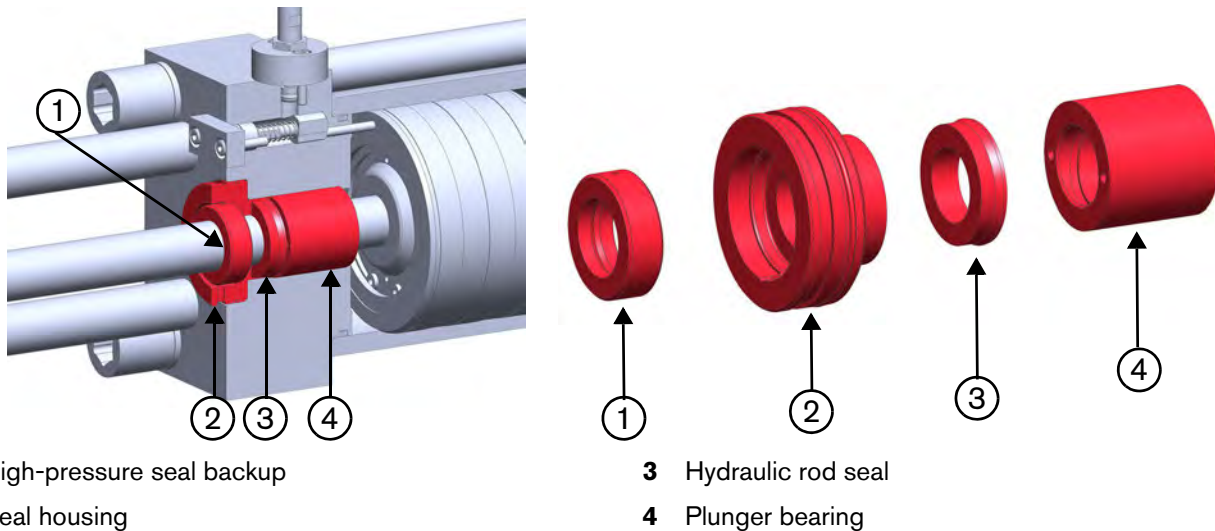

Required tools, materials, and parts

Clean, lint-free towel

Isopropyl alcohol

Seal housing removal tool (included in the HyPrecision standard tool kit)

1/8-inch hex wrench or hex-bit socket (seal housing removal tool)

Two 8-32 × 2-inch (or longer) socket-head cap screws (plunger bearing)

Recommended materials

Dental pick

1. Slide the seal housing removal tool into the groove on the seal housing.

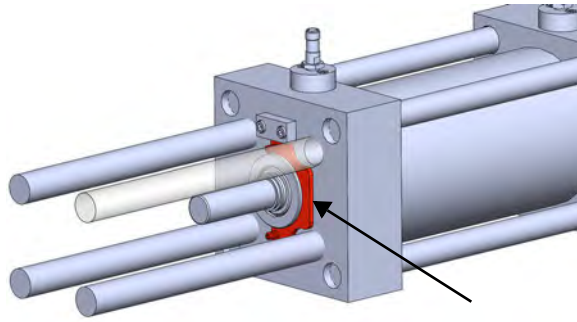

2. Use a hex wrench to turn the screws on the seal housing removal tool.

 Alternate sides so that the tool pulls the housing straight out of the high-pressure end cap.

3. Pull the seal housing and the high-pressure seal backup off the plunger.

 If the rod seal does not come out of the end cap with the seal housing, use a dental pick or other strong, narrow tool to pry it out.

4. Remove the high-pressure seal backup from the seal housing.
5. Examine the high-pressure seal backup for damage. Make sure that it fits tightly on the plunger.
6. If this preventive maintenance interval includes replacing the high-pressure seal backup and the O-ring, remove these parts from the seal housing.
7. Install 2 socket-head cap screws in the threaded holes in the plunger bearing. Use the screws to pull the plunger bearing out of the end cap.
8. Remove the plunger bearing from the plunger.
9. Clean each part with a lint-free towel and isopropyl alcohol.

	Do not use soap, detergent, or solvents.
---	--

10. Examine all parts for deterioration, corrosion, or damage.
11. Clean and examine parts that will be replaced to identify wear patterns or damage that can signify other problems.

5 – Preventive maintenance

Remove the indicator pin assembly

Replace these parts	After this many hours of operation
Indicator pin spring	3,000
Indicator pin	6,000

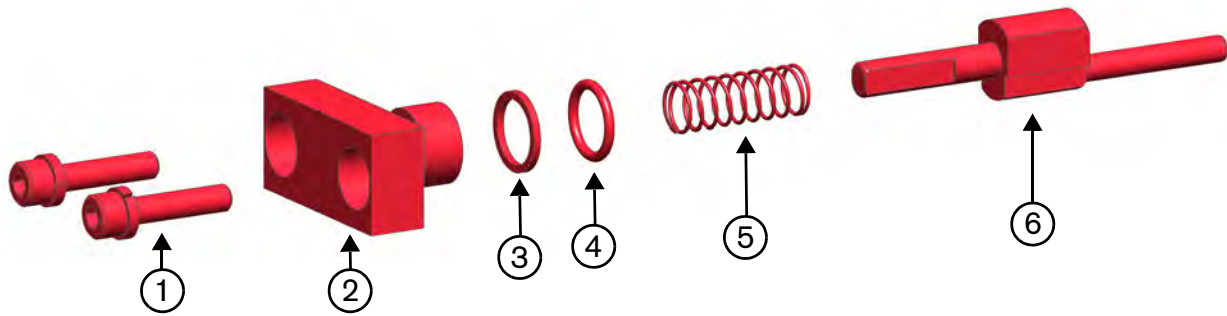

- 1 Socket-head cap screws and lock washers
- 2 Indicator pin cap
- 3 Backup ring
- 4 O-ring
- 5 Indicator pin spring
- 6 Indicator pin



Required tools, materials, and parts

Clean, lint-free towel

Isopropyl alcohol

5/32-inch hex wrench or hex-bit socket



1. Use a hex wrench to remove the socket-head cap screws and lock washers from the indicator pin cap.
2. Pull the indicator pin cap out of the hydraulic end cap.
3. If the high-pressure seal backup and the O-ring are being replaced, remove them from the indicator pin cap.
4. Remove the spring from the indicator pin.
5. Remove the indicator pin from the indicator pin hole in the end cap.
6. Clean each part with a lint-free towel and isopropyl alcohol.



Do not use soap, detergent, or solvents.

7. Examine all parts for deterioration, corrosion, or damage.
8. Clean and examine parts that will be replaced to identify wear patterns or damage that can signify other problems.

Assemble the intensifier

 CAUTION	Overtightening a fitting can cause it to fail. Use 2 wrenches when loosening or tightening a high-pressure connection. Using only 1 wrench can increase bending stress to the parts and cause damage or premature failure.
	Review the safety information on page 62.

Install the indicator pin assembly

	Put the parts on a clean, dry, oil-free surface.
---	--

 Refer to the Parts lists section, which begins on page 147, for part numbers and ordering information.

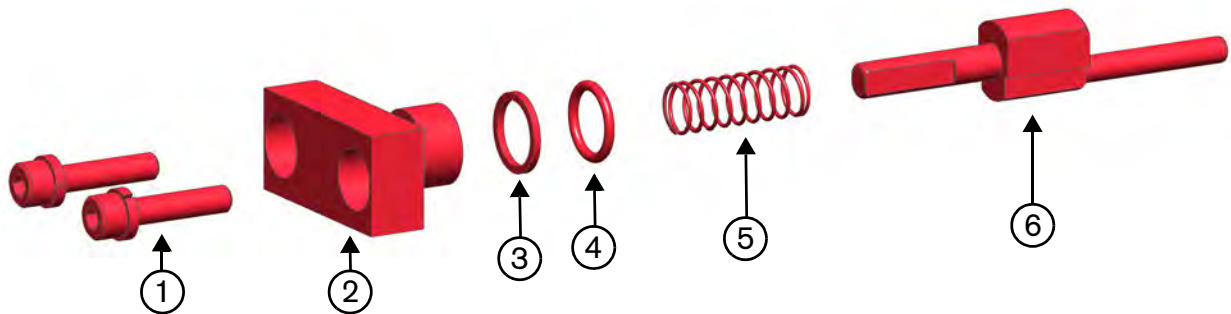

- 1 Cap screws and lock washers
- 2 Indicator pin cap
- 3 Backup ring

- 4 O-ring
- 5 Indicator pin spring
- 6 Indicator pin

 **Required tools, materials, and parts**

- 11518 Indicator pin
- 11669 Indicator pin spring
- White lithium grease antiseize bolt lubricant
- Hydraulic fluid
- Torque wrench
- 5/32-inch hex wrench or hex-bit socket

5 – Preventive maintenance

1. Put the indicator pin into the indicator pin hole in the high-pressure end cap. Turn the pin so that the offset post goes into the aperture at the back of the hole.

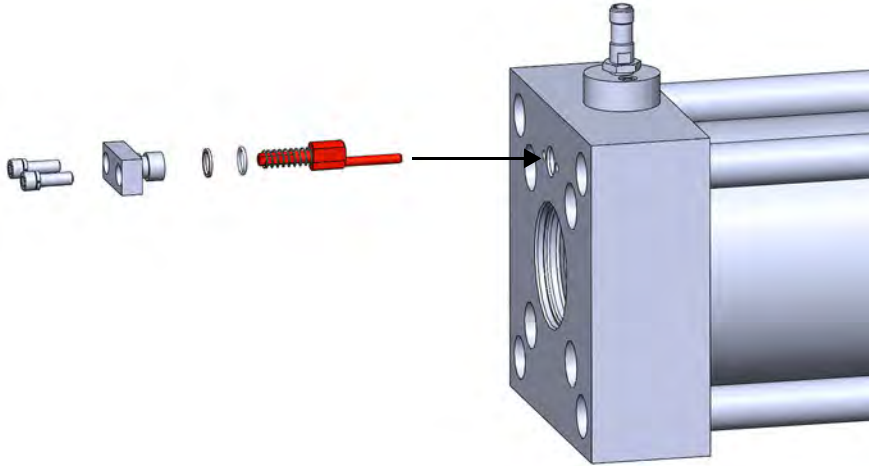

2. Put the spring on the indicator pin.
3. Put the backup on the indicator pin cap.
4. Put a small quantity of hydraulic fluid on the O-ring.
5. Put the O-ring on the indicator pin cap.
6. Put the indicator pin cap into the end cap.
7. Put white lithium grease antiseize bolt lubricant on the cap screws.
8. Put the lock washers on the cap screws. Torque the cap screws to 10 N·m (8 lbf·ft).

Install the seal housing assembly and plunger bearing



Put the parts on a clean, dry, oil-free surface.

Refer to the Parts lists section, which begins on page 147, for part numbers and ordering information.

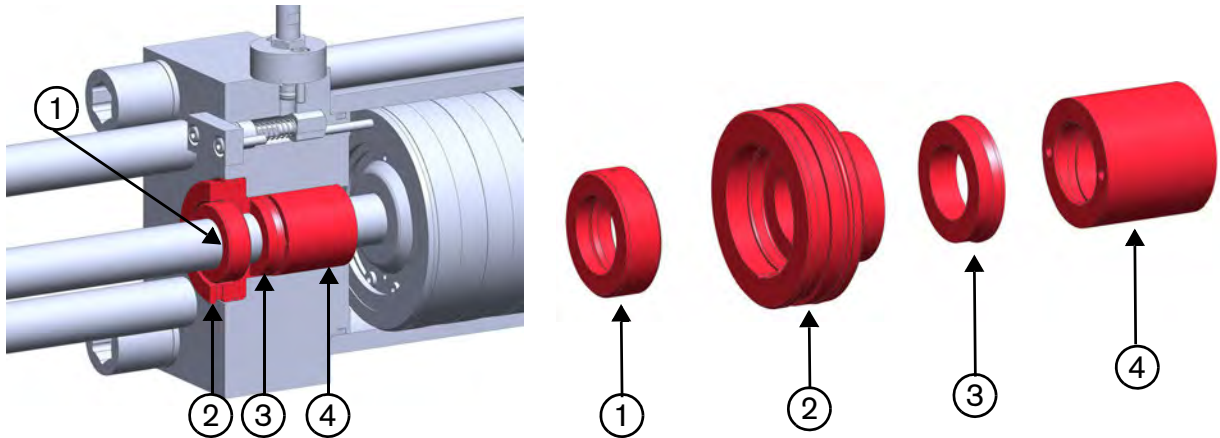

- 1 High-pressure seal backup
- 2 Seal housing

- 3 Hydraulic rod seal
- 4 Plunger bearing



Required tools, materials, and parts

15563 HyPrecision premium high-pressure seal kit

ISO viscosity grade (VG) 32 or 46 antiwear mineral or synthetic hydraulic fluid

Seal installation tools (included in the HyPrecision standard tool kit)

1. Examine the seal housing and the high-pressure seal backup. Make sure that the weep holes and inside grooves are clear of debris.

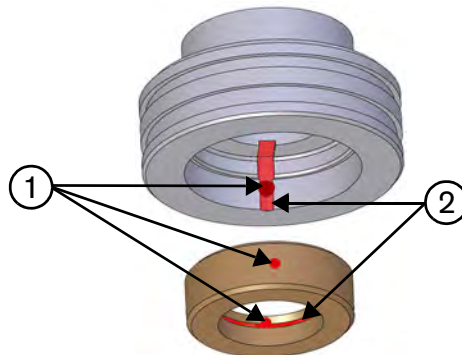

1 Weep holes

2 Grooves

2. Put O-ring lubricant on the backup ring and the O-ring.

5 – Preventive maintenance

3. Put the backup ring and the O-ring on the seal housing. The backup ring should be positioned closer to the wide end of the seal housing. The O-ring should be positioned closer to the narrow end of the seal housing.

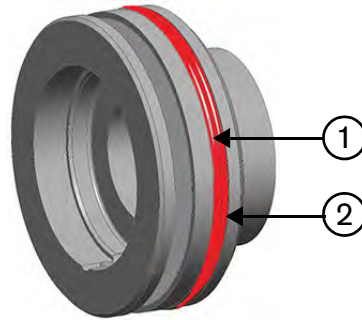

1 Backup ring

2 O-ring

4. Put the plunger bearing on the plunger and push it into the end cap.

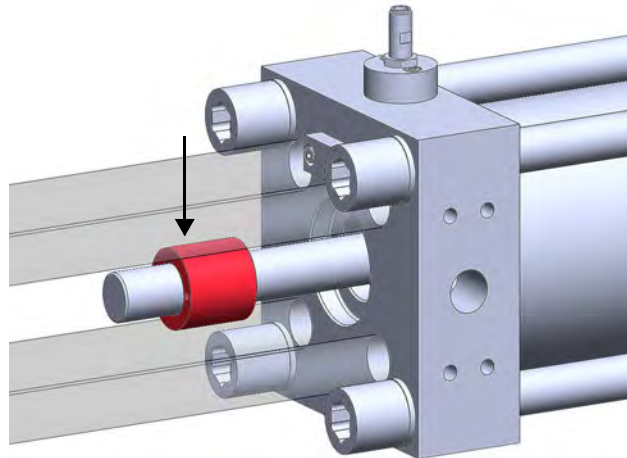

5. Put a small quantity of hydraulic fluid on the inside and the outside of the rod seal.
6. Put the rod seal onto the plunger with the wider side toward the end cap.



Do not push the rod seal into the end cap.

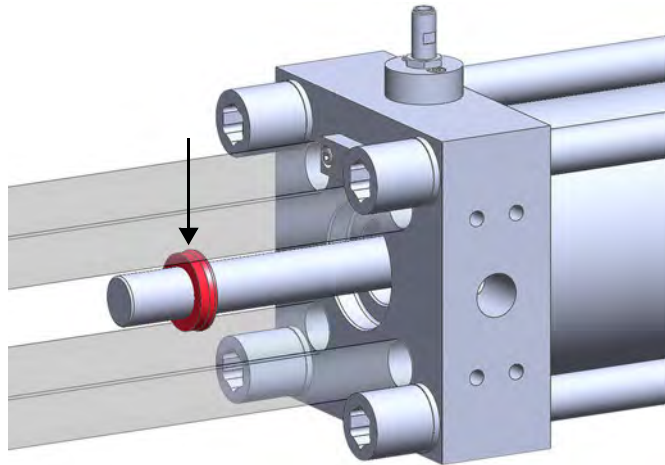

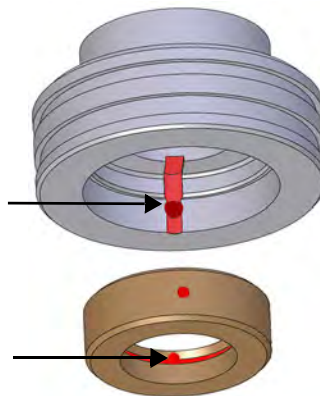

7. Put hydraulic fluid inside the narrow end of the seal housing.
8. Put the seal housing on the plunger with the narrow end toward the end cap.
9. Press the rod seal into the seal housing.
10. Turn the seal housing so that the weep hole faces down.
11. Push the seal housing tightly against the plunger bearing.
12. Turn the high-pressure seal backup so that 1 weep hole is in line with the seal housing weep hole.
13. Put the high-pressure seal backup on the plunger and push it against the seal housing.
14. Make sure that the bottom weep holes are aligned.



15. If the proximity switch was removed for this procedure, reinstall it.

5 – Preventive maintenance

Install the high-pressure water seals, high-pressure cylinder assembly, and check valve

	Do not put grease or lubricant on the check valve face or in the cylinder bore. These are designed for dry contact.
	Put the parts on a clean, dry, oil-free surface.

 Refer to the Parts lists section, which begins on page 147, for part numbers and ordering information.

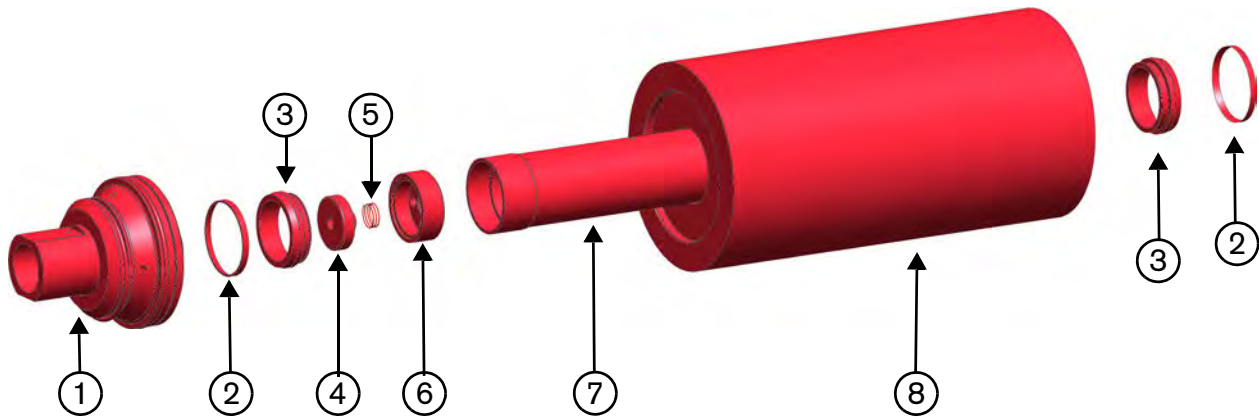

- | | | | |
|---|---------------------------|---|----------------------------|
| 1 | Check valve | 5 | Low-pressure poppet spring |
| 2 | High-pressure hoops | 6 | Low-pressure poppet basket |
| 3 | High-pressure water seals | 7 | Spacer tube |
| 4 | Low-pressure poppet | 8 | High-pressure cylinder |

Required tools, materials, and parts

- 15563 HyPrecision premium high-pressure seal kit
- 15565 HyPrecision basic poppet repair kit
- High-vacuum grease
- High-pressure antiseize lubricant such as Blue Goop or AccuGoop
- Seal installation tools (included in the HyPrecision standard tool kit)
- Rubber mallet
- 6-inch cotton-tipped applicators

1. Put the seal installation spacer tool on a clean, dry, oil-free surface.



- 1 Sleeve
- 2 Spacer tool

- 3 Push tool
- 4 Locator tool

2. Put the high-pressure cylinder over the spacer tool so that the tool fits in the cylinder bore.



5 – Preventive maintenance

3. Put the spacer tube into the high-pressure cylinder with the poppet facing up. Make sure that the poppet is flat.

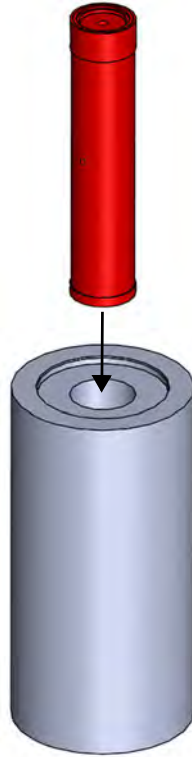

4. Put the seal installation locator tool on top of the cylinder.



- Put the seal installation sleeve in the locator tool with the flat opening toward the cylinder.

 The beveled opening faces up.



- Put a small quantity of high-vacuum grease on the red O-ring.
- Put the red O-ring into the groove on the high-pressure water seal.

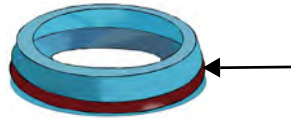

- Put the high-pressure water seal into the insertion sleeve with the red O-ring toward the cylinder.



5 – Preventive maintenance

9. Put the push tool into the insertion sleeve with the stepped end up. Press down evenly while holding the sleeve tightly against the cylinder.



10. Remove the push tool from the insertion sleeve.
11. Make sure that the seal is positioned in the cylinder correctly.

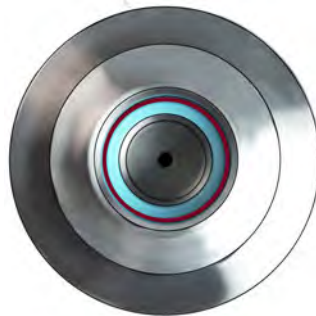

12. Put the hoop into the insertion sleeve with the sharp edge toward the cylinder.



13. Put the push tool into the insertion sleeve with the stepped end up. Tap the push tool sleeve with a rubber mallet until the push tool contacts the sleeve.

 Make sure that the sleeve is held tightly in the cylinder while tapping the push tool.

14. Remove the seal insertion push tool, sleeve, and locator.
15. Make sure that the hoop edges are even with the surface of the cylinder. If the edges are not even with the surface of the cylinder, insert the push tool and tap it with a rubber mallet.

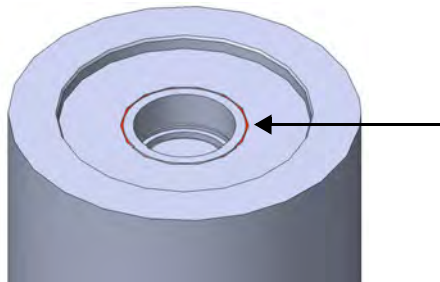

16. Put the poppet spring on the low-pressure poppet.

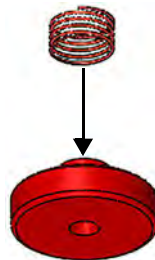

17. Put the low-pressure poppet and spring into the low-pressure poppet basket.

	Keep the poppet and poppet basket clean. Grease can cause the poppet to stick.
---	--

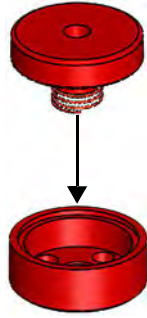

- 18.** Put the poppet assembly into the cylinder.

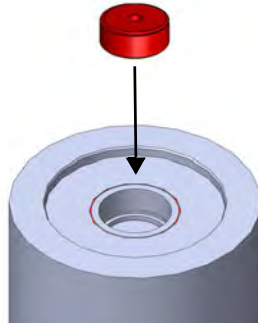

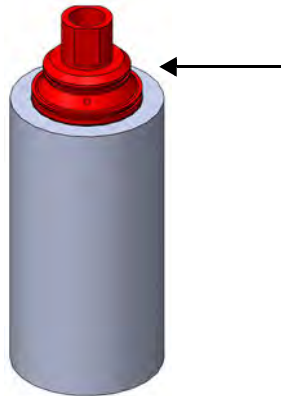

- 19.** Put the end of the check valve into the seal. Tap on the small end of the check valve with a rubber mallet until it is seated against the cylinder end.



- 20.** Turn the cylinder over so the check valve is on the bottom. Put 1 hand under the bore at the bottom of the cylinder to catch the spacer tool and to prevent the spacer tube from sliding out.
- 21.** Use the same procedure to install the second seal and hoop in the high-pressure cylinder.
- 22.** Slide the cylinder and check valve on to the plunger by pushing on the end of the check valve until the cylinder is seated against the seal housing.

Install the high-pressure end cap

 <p>CAUTION</p>	<p>Overtightening a fitting can cause it to fail. Use 2 wrenches when loosening or tightening a high-pressure connection. Using only 1 wrench can increase bending stress to the parts and cause damage or premature failure.</p>
	<p>Put the parts on a clean, dry, oil-free surface.</p>

 Refer to the Parts lists section, which begins on page 147, for part numbers and ordering information.

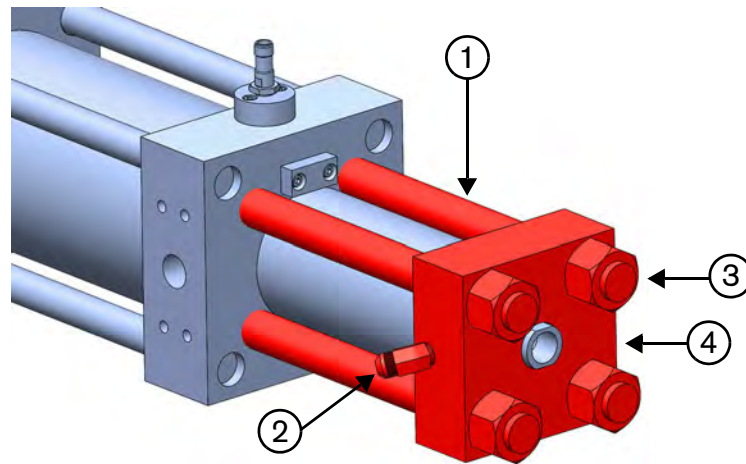

- | | |
|--|---|
| <p>1 Studs</p> <p>2 Low-pressure water fitting</p> | <p>3 Stud nuts</p> <p>4 High-pressure end cap</p> |
|--|---|

 **Required tools, materials, and parts**

- 13186 White lithium grease antiseize bolt lubricant
- High-pressure antiseize lubricant such as Blue Goop or AccuGoop
- 7/8-inch open-ended wrench (low-pressure water fitting)
- 12091 Torque wrench, 3/4-inch drive, 60 lbf·ft to 300 lbf·ft (included in the HyPrecision standard tool kit)
- Square drive socket, 1-1/2 inch × 3/4 inch (stud nuts) (included in the HyPrecision standard tool kit)

1. Put the end cap onto the check valve and studs with the water fitting pointed toward the attenuator.
2. Put white lithium grease on the stud threads.
3. Hand tighten the nuts on the studs.

 Put the smooth side of the nut toward the end cap.

5 – Preventive maintenance

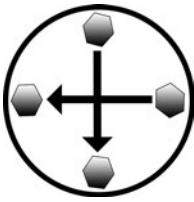

4. Torque the stud nuts to 373 N·m (275 lbf·ft).

 Tighten each nut in 45° increments using a repeating sequential cross pattern until the recommended torque is reached.



5. Connect the low-pressure water line.
6. Torque the low-pressure water fitting to 31 N·m to 41 N·m (25 lbf·ft to 30 lbf·ft).

Install the output adapter and the high-pressure poppet assembly

 <p>CAUTION</p>	<p>Overtightening a fitting can cause it to fail. Use 2 wrenches when loosening or tightening a high-pressure connection. Using only 1 wrench can increase bending stress to the parts and cause damage or premature failure.</p>
	<p>Put the parts on a clean, dry, oil-free surface.</p>

 Refer to the Parts lists section, which begins on page 147, for part numbers and ordering information.

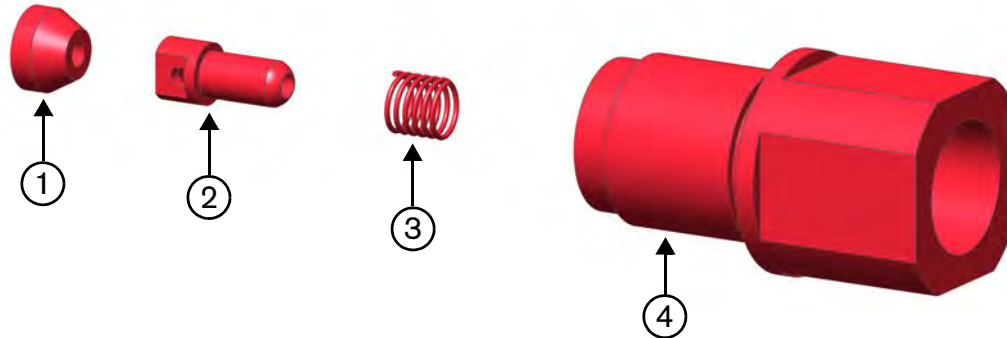

- 1 High-pressure poppet seat
- 2 High-pressure poppet
- 3 High-pressure poppet spring
- 4 Output adapter

 **Required tools, materials, and parts**

- 15565 HyPrecision basic poppet repair kit
- High-pressure antiseize lubricant such as Blue Goop or AccuGoop
- 1-inch open-ended crowfoot wrench or socket (check valve and output adapter)
- 13/16-inch open-ended crowfoot wrench or socket (high-pressure water fitting)
- Torque wrench
- 6-inch cotton-tipped applicators (included in the HyPrecision standard tool kit)

1. Use a cotton-tipped applicator to put high-pressure antiseize lubricant in the recess in the bottom of the check valve.

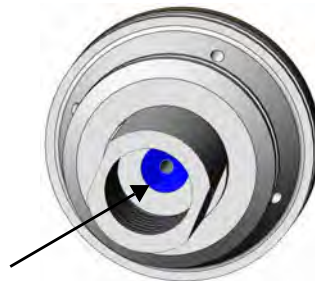

5 – Preventive maintenance

2. Use a cotton-tipped applicator to guide the high-pressure seat into the check valve. The wide end of the seat should face down.

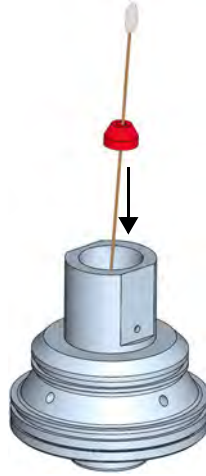

3. Press the seat into the high-pressure antiseize lubricant in the check valve. The lubricant holds the seat in position.
4. Put high-pressure antiseize lubricant on the threads of the output adapter.

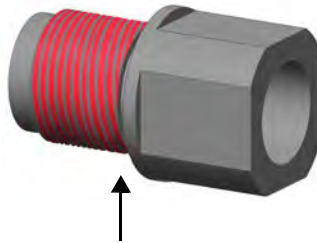

5. Put the high-pressure poppet spring and the poppet in the output adapter.

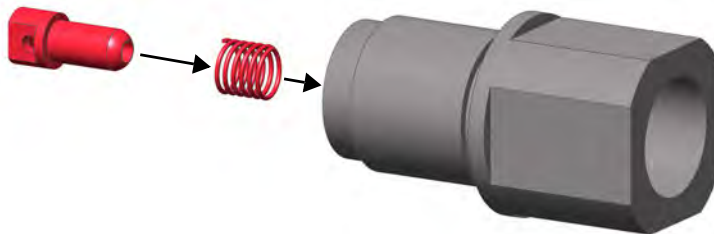

6. Put the output adapter in the check valve and tighten it by hand.



Tightening the output adapter with a poppet out of position can cause damage.

When properly seated, the gap between the wide part of the output adapter and the check valve is 10 mm (3/8 inch). If the gap is larger, make sure that the poppet parts have not moved.

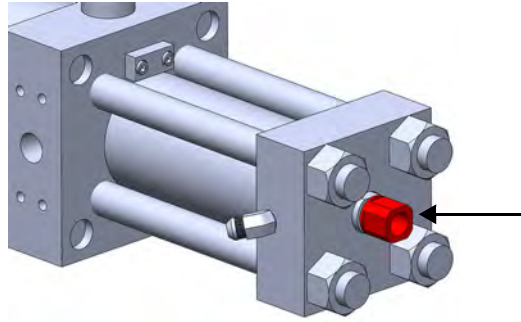





7. Torque the output adapter to 41 N·m to 47 N·m (30 lbf·ft to 35 lbf·ft).
8. Put high-pressure antiseize lubricant on the high-pressure connector threads.
9. Connect the high-pressure water line.

 Make sure that a few of the threads on the collar are visible.

10. Torque the high-pressure water fitting to 41 N·m to 47 N·m (30 lbf·ft to 35 lbf·ft).

Service the bleed-down valve

 CAUTION	Failure to correct the cause of a leak can result in damage to the fittings.
	Repair or replace parts identified in the preventive maintenance schedule or if the parts show signs of deterioration, corrosion, or damage.
	Put the parts on a clean, dry, oil-free surface.

 Use 2 wrenches when loosening or tightening a high-pressure connection. Using only 1 wrench can increase bending stress to the parts and cause damage or premature failure.

 Refer to the Parts lists section, which begins on page 147, for part numbers and ordering information.

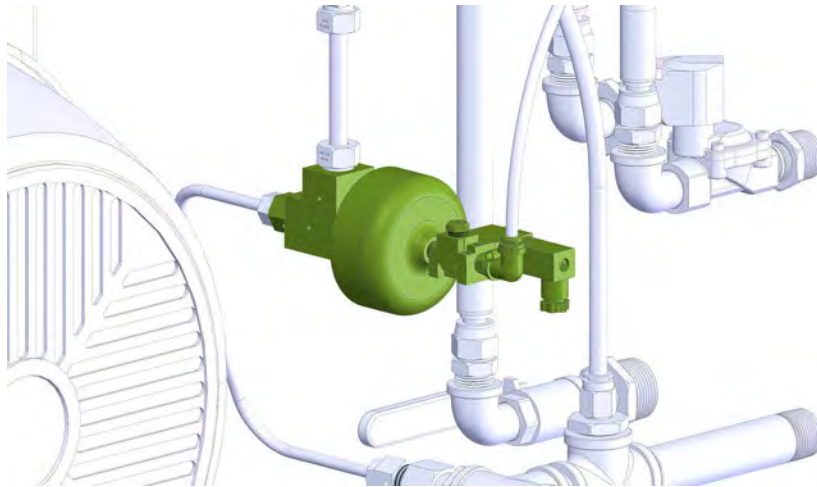

Required tools, materials, and parts

- 5/8-inch open-ended wrench
- 3/4-inch open-ended wrench
- 13/16-inch open-ended wrench
- 1-inch open-ended wrench
- Cross-tip screwdriver

Do this task when the pump is not running.

1. Turn OFF the water to the pump.

2. Open the valve to drain the water from the system. Make sure that the water pressure gauges show 0.0 bar or 0 kPa (0 psi).

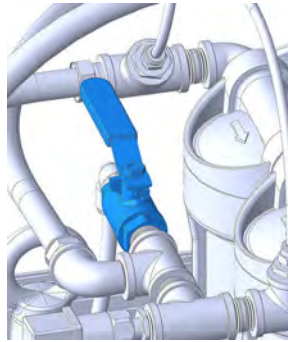

Water valve in open position

3. Use a cross-tip screwdriver to remove the electrical connector from the actuator housing.

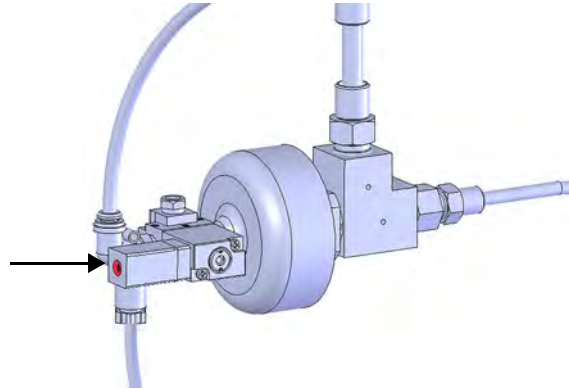

4. Disconnect the compressed-air line from the solenoid valve.

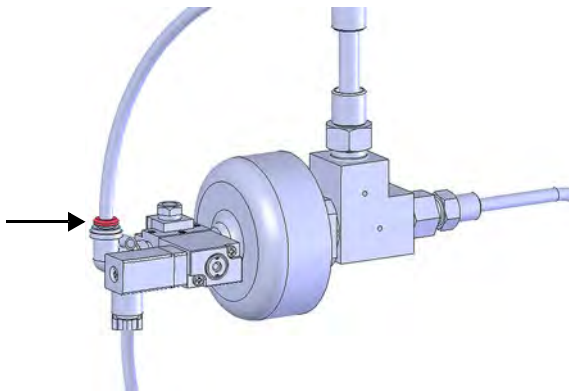

5 – Preventive maintenance

5. Remove the gland nut connecting the water drain tubing to the bleed-down valve.

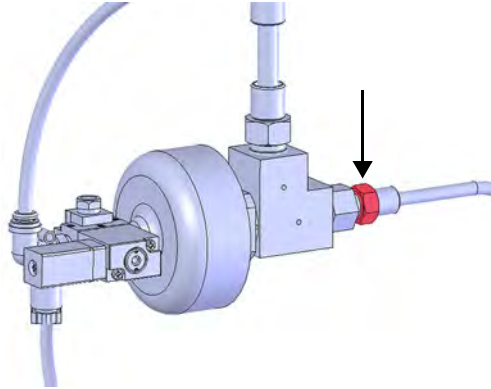

6. Remove the gland nut on the high-pressure collar at the high-pressure fitting of the valve.

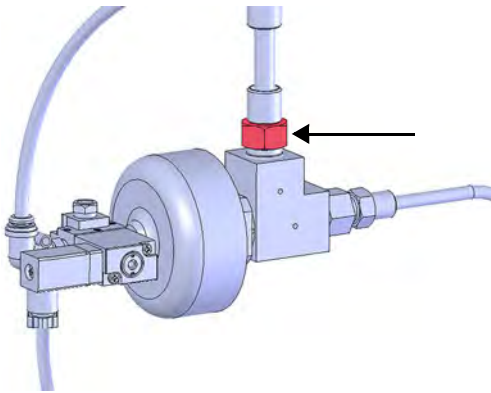

7. Remove the bleed-down valve assembly from the pump.

Disassemble the bleed-down valve

Repair the bleed-down valve after every 1,000 hours of operation.

Replace the bleed-down valve body after every 3,000 hours of operation.

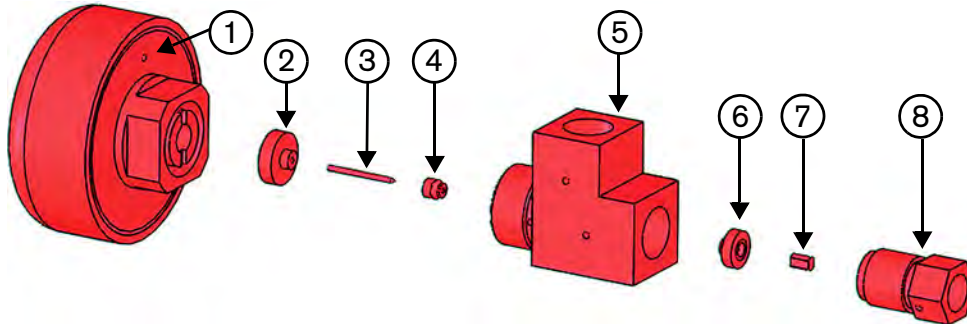

- | | |
|----------------------------|------------------|
| 1 Actuator | 5 Valve body |
| 2 Needle guide | 6 Seat |
| 3 Needle | 7 Flow reducer |
| 4 High-pressure valve seal | 8 Outlet adapter |



Required tools, materials, and parts

- Clean, lint-free towel
- Isopropyl alcohol
- 3/4-inch open-ended wrench
- 1-1/8-inch open-ended wrench (to hold the valve body)
- Wooden dowel

1. Remove the outlet adapter from the valve body.
2. Remove the seat and the flow reducer from the outlet adapter.
3. Remove the actuator from the valve body.
4. Push a dowel through the bottom of the valve body to remove the seal, the needle guide, and the needle.

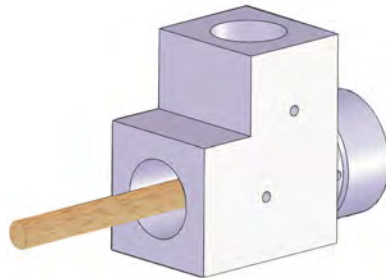

5 – Preventive maintenance

5. Clean each part with a lint-free towel and isopropyl alcohol.



Do not use soap, detergent, or solvents.

6. Examine all parts for deterioration, corrosion, or damage.
7. Clean and examine parts that will be replaced to identify wear patterns or damage that can signify other problems.
8. Discard the used parts.

Assemble the bleed-down valve



Overtightening a fitting can cause it to fail. Use 2 wrenches when loosening or tightening a high-pressure connection. Using only 1 wrench can increase bending stress to the parts and cause damage or premature failure.

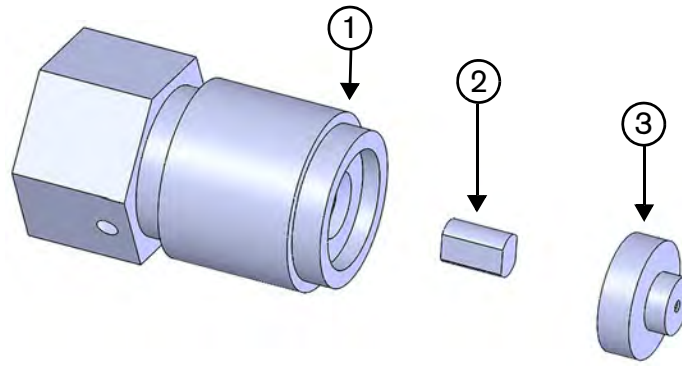

- 1 Outlet adapter
- 2 Flow reducer

3 Seat



Required tools, materials, and parts

11328 On/off valve and bleed-down valve repair kit

11743 Bleed-down valve flow reducer

High-pressure antiseize lubricant such as Blue Goop or AccuGoop

1-inch open-ended wrench

3/4-inch open-ended crowfoot wrench or socket

Torque wrench

Cross-tip screwdriver

1. Put high-pressure antiseize lubricant on the seat.
2. Put the flow reducer into the outlet adapter.
3. Put the seat into the outlet adapter.
4. Install the outlet adapter in the bleed-down valve body. Torque the adapter to 27 N·m (20 lbf·ft).



Use 2 wrenches.

5 – Preventive maintenance

5. Put the needle through the needle guide and the valve seal.

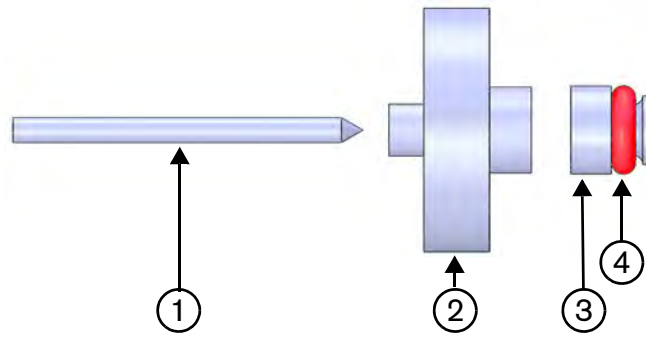

1 Needle

2 Needle guide

3 Valve seal

4 O-ring

 Make sure that the point of the needle faces the seal.

6. Put high-vacuum grease on the red O-ring on the valve seal. Make sure that the red O-ring on the valve seal faces away from the needle.
7. Put the needle-and-seal assembly into the valve body until the needle guide is even with the top of the bore.
8. Install the actuator on the valve body. Turn the actuator until it is hand tight.

Install the bleed-down valve



Overtightening a fitting can cause it to fail. Use 2 wrenches when loosening or tightening a high-pressure connection. Using only 1 wrench can increase bending stress to the parts and cause damage or premature failure.



Required tools, materials, and parts

- 5/8-inch open-ended wrench
- 3/4-inch open-ended wrench
- 13/16-inch open-ended wrench
- 1-inch open-ended wrench
- Torque wrench

1. Tighten the gland nut on the high-pressure collar at the high-pressure fitting of the valve. Refer to the Fittings section, which begins on page 173, for the fittings torque values.

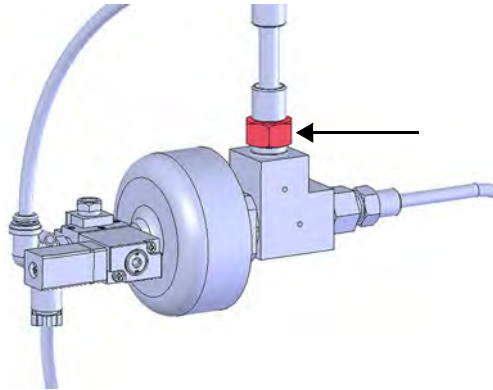

2. Tighten the gland nut connecting the water drain tubing to the bleed-down valve. Refer to the Fittings section, which begins on page 173, for the fittings torque values.

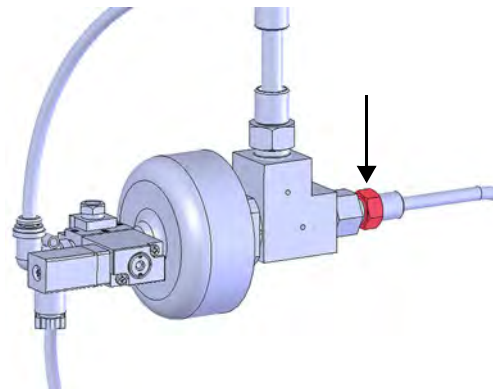

5 – Preventive maintenance

3. Attach the electrical connector to the solenoid valve on the actuator housing.

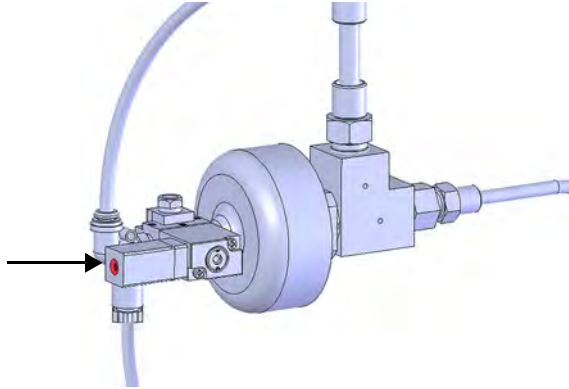

4. Connect the compressed-air line to the solenoid valve.

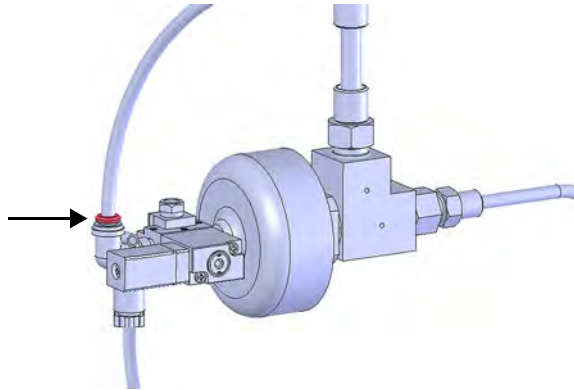





5. Close the water valve.





Water valve in closed position

6. Turn ON the water to the pump.

Start the pump after preventive maintenance

DANGER	A turning motor shaft can be dangerous.
 CAUTION	Close all doors and replace all covers, including the shaft access cover.
 CAUTION	Failure to correct the cause of a leak can result in damage to the fittings.
	Test the equipment before putting it into use.
	Make sure that all fittings are tight after doing maintenance or repairing this pump.

1. Turn ON the water supply.
2. Turn ON the air supply.
3. Turn ON the electrical main.
4. Make sure that the primary breaker disconnect lever on the electrical enclosure door is in the ON position.
 -  The operator interface screen is illuminated when electricity to the pump is turned on.
5. Make sure that the LOCAL/REMOTE key switch on the operation panel is in the LOCAL position.
6. Press the CONTROLS ON button to turn on the control circuit inside the pump.
 -  The pump can not be turned on until the circuit is turned on.
7. Turn ON the pump in cooling mode to let water to fill the intensifier.
8. Turn the pierce-pressure adjustment knob to the left (anticlockwise) to decrease the pierce pressure. Refer to page 54 for instructions.
9. Press F1 on the operator interface to turn on the pump and the intensifier.
10. Press 1 on the numeric keypad to change the pump to pierce-pressure mode.
11. Turn ON the cutting head to clear air from the high-pressure lines. Watch for water to come out of the cutting head. This takes approximately 1 minute.
 -  It is normal for the intensifier to stroke very quickly while it pushes the air out of the lines.
12. Permit the intensifier to stroke for a few minutes to make sure that the seals seat properly.
13. Turn OFF the cutting head.

5 – Preventive maintenance

14. Check the high-pressure water, the low-pressure water, and the hydraulic systems for leaks. If a leak is found, identify the source and repair the problem. Refer to the Troubleshooting section, which begins on page 153.
15. Turn the pierce-pressure adjustment knob to the right (clockwise) to increase the pierce-pressure to the desired pierce-pressure set point.
16. Press 1 on the numeric keypad to change the pump to cut-pressure mode. The intensifier strokes until the pump reaches the high-pressure setting and then it stops stroking.
17. Check the high-pressure water, the low-pressure water, and the hydraulic systems for leaks. If a leak is found, identify the source and repair the problem. Refer to the Troubleshooting section, which begins on page 153.

The pump is ready for normal operation.

Preventive maintenance interval checklist

Every 40 hours (page 76)

- Measure the hydraulic fluid temperature.

Every 500 hours (page 78)

- Measure the pressure in the water accumulator tank.
- Repair the check valves.
- Repair the low-pressure poppets.
- Replace the high-pressure water seals, the hoops, and the high-pressure seal backups.
- Replace the hydraulic rod seals.
- Repair the high-pressure cylinders.

Every 1,000 hours (page 85)

- Measure the pressure in the water accumulator tank.
- Replace the water filters.
- Test the low-pressure water TDS level.
- Measure the hydraulic fluid temperature.
- Repair the check valves.
- Replace the high-pressure water seals, the hoops, and the high-pressure seal backups.
- Replace the hydraulic rod seals.
- Repair the high-pressure cylinders.
- Replace the high-pressure poppet assemblies.
- Replace the low-pressure poppets and poppet springs.
- Repair the bleed-down valve.

Every 1,500 hours (page 92)

- Measure the pressure in the water accumulator tank.
- Replace the hydraulic filter.
- Repair the check valves.
- Repair the low-pressure poppets.
- Replace the high-pressure water seals, the hoops, and the high-pressure seal backups.
- Replace the hydraulic rod seals.
- Repair the high-pressure cylinders.
- Replace the high-pressure poppet assemblies.
- Replace the low-pressure poppets and poppet springs.

Every 2,000 hours (page 93)

- Measure the pressure in the water accumulator tank.
- Replace the water filters.
- Test the low-pressure water TDS level.
- Measure the hydraulic fluid temperature.
- Replace the high-pressure water seals, the hoops, and the high-pressure seal backups.
- Replace the hydraulic rod seals.
- Repair the high-pressure cylinders.
- Replace the high-pressure poppet assemblies.
- Replace the low-pressure poppets and poppet springs.
- Replace the check valves.
- Replace the low-pressure poppet baskets.
- Repair the bleed-down valve.

Every 3,000 hours (page 94)

- Measure the pressure in the water accumulator tank.
- Replace the water filters.
- Test the low-pressure water TDS level.
- Measure the hydraulic fluid temperature.
- Replace the hydraulic filter.
- Replace the hydraulic fluid.
- Replace the high-pressure water seals, the hoops, and the high-pressure seal backups.
- Replace the hydraulic rod seals.
- Replace the high-pressure poppet assemblies.
- Replace the low-pressure poppets and poppet springs.
- Replace the high-pressure cylinders.
- Replace the plunger bearings.
- Replace the indicator pin springs.
- Replace the bleed-down valve body.

Every 6,000 hours (page 100)

- Measure the pressure in the water accumulator tank.
- Replace the water filters.
- Test the low-pressure water TDS level.
- Measure the hydraulic fluid temperature.
- Replace the hydraulic filter.
- Replace the hydraulic fluid.
- Replace the high-pressure water seals, the hoops, and the high-pressure seal backups.
- Replace the hydraulic rod seals.
- Replace the high-pressure poppet assemblies.
- Replace the low-pressure poppets and poppet springs.
- Replace the check valves.
- Replace the low-pressure poppet baskets.
- Repair the high-pressure cylinders.
- Replace the plunger bearings.
- Replace the indicator pins.
- Replace the output adapters.
- Replace the seal housings.
- Replace the indicator pins. the indicator pins.
- Replace the bleed-down valve body.

Every 12,000 hours (page 101)

- Measure the pressure in the water accumulator tank.
- Replace the water filters.
- Test the low-pressure water TDS level.
- Measure the hydraulic fluid temperature.
- Replace the hydraulic filter.
- Replace the hydraulic fluid.
- Replace the high-pressure water seals, the hoops, and the high-pressure seal backups.
- Replace the hydraulic rod seals.
- Replace the high-pressure poppet assemblies.
- Replace the low-pressure poppets and poppet springs.
- Repair the check valves.
- Replace the low-pressure poppet baskets.
- Repair the high-pressure cylinders.
- Replace the plunger bearings.
- Replace the indicator pin springs.
- Replace the output adapters.
- Replace the seal housings.
- Replace the indicator pins.
- Replace the spacer tubes.
- Service the hydraulic center section.
- Replace the bleed-down valve body.

5 – Preventive maintenance

Preventive maintenance records

Problem found and work done

Date	
Hours	
Initials	
Date	
Hours	
Initials	
Date	
Hours	
Initials	
Date	
Hours	
Initials	
Date	
Hours	
Initials	
Date	
Hours	
Initials	
Date	
Hours	
Initials	
Date	
Hours	
Initials	

Problem found and work done

Date	
Hours	
Initials	
Date	
Hours	
Initials	
Date	
Hours	
Initials	
Date	
Hours	
Initials	
Date	
Hours	
Initials	
Date	
Hours	
Initials	
Date	
Hours	
Initials	
Date	
Hours	
Initials	
Date	
Hours	
Initials	
Date	
Hours	
Initials	

Preventive maintenance

Section 6

Parts lists

Genuine Hypertherm parts are the factory-recommended replacement parts for this pump. The Hypertherm warranty might not cover damage caused by using nongenuine Hypertherm parts.

To order parts, contact the original equipment manufacturer (OEM) or Hypertherm Inc. with the part numbers and quantities.

Hypertherm Waterjet

305 2nd Street Suite 115

New Brighton, MN 55112 USA

+1 866-566-7099

+1 651-294-8620 fax

Tools

12084 HyPrecision standard tool kit

Part number	Description
11448	AccuGoop, 4 oz.
11558	Seal installation locator tool
11811	Seal installation sleeve
11812	Seal installation push tool
12932	Seal installation spacer tool
11985	Seal housing removal tool
12019	Hex driver, 3/4 in. × 13-1/2 in.
12020	Deep square-drive socket, 3/4 in. × 3/4 in.
12021	Square-drive socket, 1-1/2 in. × 3/4 in.
12091	Torque wrench, 3/4-in. drive, 60 lbf·ft to 300 lbf·ft
13972	Water filter wrench
13281	Surface plate, 9 in. × 12 in. × 2 in.
11210-12	Lapping paper, 12 micron
11210-15	Lapping paper, 15 micron

Other tools

Part number	Description
13897	TDS meter
11210-30	Lapping paper, 30 micron

Preventive maintenance repair kits

Quantify refers to the number of units included with each part number.

15566 HyPrecision basic standard spares kit

Part number	Description	Quantity
15563	HyPrecision premium high-pressure seal kits	2
15565	HyPrecision basic poppet repair kit	1
11328	On/off valve and bleed-down valve repair kit	1
11669	Indicator pin springs	2
11679-013	Indicator cap O-rings, -013	2
11680-013	Indicator cap O-ring backups, -013	2
15564	6-inch cotton-tipped applicators (cotton swabs)	2
11105	Water filter cartridge, 0.45 micron, 10 in.	1
11106	Water filter cartridge, 1.0 micron, 10 in.	1
16025	Hydraulic filter, 10 micron, absolute	1

15563 HyPrecision premium high-pressure seal repair kit

Part number	Description	Quantity
11018	Hoops, 1 in.	4
11024	Seals, 1 in.	4
11447	High-vacuum grease, seal O-ring lubricant, 5 oz.	1
11610	High-pressure seal backup (bronze)	2
11090	Rod seals, 1 in.	2
11679-035	Check valve and seal housing O-rings, -035	4
11679-031	Check valve O-rings, -031	2
11680-035	Seal housing O-ring backups, -035	2

15565 HyPrecision basic poppet repair kit

6 – Parts lists

Quantify refers to the number of units included with each part number.

Part number	Description	Quantity
11014	High-pressure poppets	2
11126	Poppet springs	2
11015	High-pressure seats	2
14792	Low-pressure poppets	2
13907	Low-pressure poppet springs	2
15564	6-inch cotton-tipped applicators (cotton swabs)	2

11328 On/off valve and bleed-down valve repair kit

Part number	Description	Quantity
11010	AccuSeat	1
11562	Needle	1
12178	Needle guide	1
11043	Valve seal	1
11447	High-vacuum grease, seal O-ring lubricant, 5 oz.	1

Other parts

Part number	Description
11743	Bleed-down valve flow reducer
14141	High-performance bleed-down valve body
11523	Check valve assembly
11520	Low-pressure poppet basket
11530	Output adapter
11522	High-pressure cylinder
11609	Seal housing
11608	Plunger bearing
11521	Spacer tube
16025	Hydraulic filter, 10 micron, absolute
12438	Suction strainer, 1-1/2 in.
11960	Suction strainer, 2-1/2 in.
14629	Filler-breather cap
11518	Indicator pin
11669	Indicator pin spring
11111	Blue Goop high-pressure antiseize lubricant
11448	AccuGoop food-grade high-pressure antiseize lubricant
11447	High-vacuum grease
11136	Silicone-based high-vacuum grease
13969	Petroleum-based O-ring lubricant
13186	White lithium grease antiseize bolt lubricant
11120	Blue 242 thread sealant







Refer to page 67 for a complete list of preventive maintenance kits, parts, tools, and materials.

Section 7

Troubleshooting

Safety

	Refer to the instruction manual. Read and understand all of the safety guidelines in this manual.
 WARNING	Use a piece of cardboard or other solid material to find leaks when the pump is operating. Do not use hands, cloth, paper, or towels.
 WARNING	Do not touch a hot surface. Fittings can get hot, especially when they are not properly tightened.
 CAUTION	Failure to correct the cause of a leak can cause damage to the water fittings.

 Hypertherm products are designed and manufactured with a commitment to continuous quality control and safety. Contact a Hypertherm Technical Service Associate for information about the installation, operation, maintenance, and repair of this equipment.

Tips

- Turn ON the electrical breakers, install all covers, and close all doors before restarting the pump.
- Keep all interior parts and surfaces clean. Put all parts on a clean work surface.
- Handle high-pressure parts with clean hands.
- Before reassembling high-pressure or hydraulic parts, clean the parts to remove dirt and other contaminants.

Alarm screens

The programmable controller monitors activities while the pump is running. When the controller detects a problem with the system, the operator interface shows a status symbol and the stack light blinks. When operating the intensifier or primary motor is likely to damage the system, the intensifier and the primary motor turn off.

Press F1 on the operator interface to stop an alarm. The alarm screen closes and the stack light stops blinking.

The amber stack light blinks to signal a condition that requires attention. The red stack light blinks to show that a fault has occurred.



Not all pump functions are monitored by the programmable controller.

The pump will not start

If the pump does not start or does not increase pressure, check these possible causes.

- The primary power is off.
- The primary breaker disconnect lever is off.
- The LOCAL/REMOTE key switch is in the LOCAL position and the pump is being operated remotely.
- The pump is in pierce-pressure mode and the pierce-pressure adjustment knob is turned to the left too much.
- The pressure-enable valve has failed.
- A motor overload relay has tripped.
- A fuse in the electrical enclosure has blown.
- The pressure-relief valve on the primary hydraulic manifold has failed.

Intensifier

Stroking problems



It is normal for the intensifier to stroke faster during startup and when changing from pierce-pressure mode to cut-pressure mode.



The motor's wattage and the size of the hydraulic pump determine the maximum intensifier stroke rate.

If the intensifier does not stroke to either side, check these possible causes.

- Make sure that the intensifier is enabled. Refer to page 57 for instructions for disabling and enabling the intensifier.
- Make sure that the cutting head is turned on.
- Look at the proximity switch lights. If both lights are on at the same time, a proximity switch might have failed, an indicator spring might be broken, or an indicator pin might be stuck. Inspect all parts to determine the cause of the fault.
- Check the cord ends on the proximity switches for damage.
- Make sure that the indicator pins and springs are not damaged.

If the intensifier strokes to 1 side and then stalls on the same side, check these items.

- Trade the proximity switches (but not the wires).
- Replace the proximity switches.
- Check the indicator pin for burrs. The pins should move freely to the bottom of the bore.
- Make sure that the indicator pin springs are not broken and that they are the same length.
- While the pump is in cooling mode, push on the shift pin on the stalled side.



The shift pin is found at the ends of the coil on the pilot valve. If the intensifier strokes to other side, the problem is electrical. If the intensifier does not move, the problem is mechanical.

If the intensifier strokes but there is not enough pressure at the cutting head, check these items.

- Replace the water filter.
- Repair or replace the thimble filter for the on/off valve.
- Make sure that there is not an obstruction in the high-pressure tubing.
- The hydraulic piston seals could be worn. Contact Hypertherm Technical Service for support.
- If a high-pressure cylinder is hot, disassemble it and look for flaws, deterioration, erosion marks, or cracks in the parts, including the check valve and piston seal.
- If an output adapter is hot, check the high-pressure poppet and the high-pressure seat.
- If the bleed-down valve is hot or if water is coming out of the pump drain line, repair the bleed-down valve.
- Make sure that the number of orifices and their sizes are sufficient for the pump's output.

Overstroking

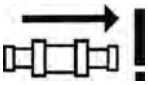
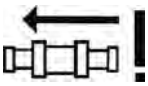

Symbol	Fault/warning	Stack light	Result
	Intensifier overstroke to the right	Red	The intensifier turns off. The pump runs in cooling mode.
	Intensifier overstroke to the left		
The display does not show a symbol for overstroking in both directions. The screen will show 1 of the overstroke symbols above.	Intensifier overstroke in both directions		

The intensifier usually strokes smoothly to the left and to the right at the same speed. An overstroke fault occurs when the hydraulic piston travels faster in 1 or both directions than the waterjet pump can support. It is normal for the intensifier to stroke faster during startup and when changing from pierce-pressure mode to cut-pressure mode.

The overstroke alarm is triggered by three conditions: overstroking to the right, overstroking to the left, or overstroking in both directions. If the overstroke alarm is on, follow these steps.

1. Press F1 on the operator interface to stop an alarm. The alarm screen closes and the stack light stops blinking.
2. Turn OFF the cutting head.
3. Turn ON the pump in running mode.
4. Turn ON the cutting head. The intensifier begins to stroke.
5. Put the pump in cut-pressure mode.
6. Monitor the intensifier stroke rate indicator on the operator interface.

7. If the intensifier over-strokes in both directions, check these possible causes.

Possible cause	Solution
The orifice is worn, has failed, or is improperly installed.	Reinstall or replace the orifice.
The high-pressure water seals are worn or damaged.	Replace or replace the high-pressure water seals.
The high-pressure plumbing (a water line or a fitting) is leaking.	Find and repair the leak.
The bleed-down valve is leaking.	Repair or replace the bleed-down valve.
The needle and seat in the cutting head are leaking.	Repair or replace the cutting head.
The low-pressure water relief valve is venting water to the drain.	Remove the 3/8-inch tubing from the valve at the outlet fitting and check for water leaking.  Call Hypertherm for help with adjusting the valve.
The postfilter water-pressure gauge shows that the pressure for the inlet cutting water is lower than 2.8 bar or 275 kPa (40 psi).	If the difference between the values on the pre- and post-filter water-pressure gauges is higher than 0.7 bar or 69 kPa (10 psi), replace both water filters.
The prefilter water-pressure gauge shows that the pressure of the inlet cutting water is lower than 2.8 bar or 275 kPa (40 psi).  The intensifier can starve for water without activating the low-pressure alarm for the inlet cutting water.	<ul style="list-style-type: none"> ▪ Make sure that the inlet cutting water supply is turned on. ▪ Make sure that the water valve is closed. ▪ Make sure that the low-pressure water is connected to the intensifier. ▪ Check the inlet cutting water solenoid by loosening a brass fitting after the solenoid while the pump is running. Water should immediately stream from the loosened fitting.

 Instructions about how to disassemble the intensifier and how to repair or replace its parts begin on page 102.

7 – Troubleshooting

8. If the intensifier overstrokes in one direction, check these possible causes.

Possible cause	Solution
The high-pressure water seals are worn or damaged.	Replace the high-pressure water seals.
A low-pressure poppet is sticking, worn, or damaged. Overstroking to the left means that there is a failure of the low-pressure poppet on the left side of the intensifier. Overstroking to the right means that there is a failure of the low-pressure poppet on the right side of the intensifier.	<ul style="list-style-type: none">▪ Examine the face of the poppet and the mating face on the check valve. Both surfaces should have a mirrorlike finish.▪ Repair or replace the poppet.▪ Make sure that the low-pressure poppet fits in the basket without sticking.▪ Repair or replace the check valve.
A high-pressure poppet is sticking, worn, or damaged. Overstroking to the left means that there is a failure of the high-pressure poppet on the right side of the intensifier. Overstroking to the right means that there is a failure of the high-pressure poppet on the left side of the intensifier.	<ul style="list-style-type: none">▪ Check for heat from the output adapter on the intensifier end opposite the direction of overstroke. If the output adapter is hot, remove it from the check valve and examine the high-pressure poppet, spring, and seat.▪ Replace the high-pressure poppet, seat, and spring.



Instructions about how to disassemble the intensifier and how to repair or replace its parts begin on page 102.

9. A worn or damaged orifice can increase the demand for high-pressure water from the intensifier and cause an overstroke fault. Make sure that the orifice is not damaged.

Leaks

Make sure that the tubing, water fittings, and quick disconnects inside and outside of the pump are not leaking.

Damage to the high-pressure water seals and the hoops is the most common cause of water leaking from the intensifier. Water dripping from the high-pressure cylinder shows that the seals will soon require changing. One drip every few strokes means that the seals should be watched. More than 1 drip with each stroke means that the seals in that high-pressure cylinder should be changed at the first opportunity.

Weep holes throughout the high-pressure water system let water escape from leaking parts. Leaks can mean that there is a faulty part, loose fitting, or damaged seat. Failure to correct the problem can result in damage to the mating fittings.

 Look for leaks at both ends of the high-pressure cylinder.

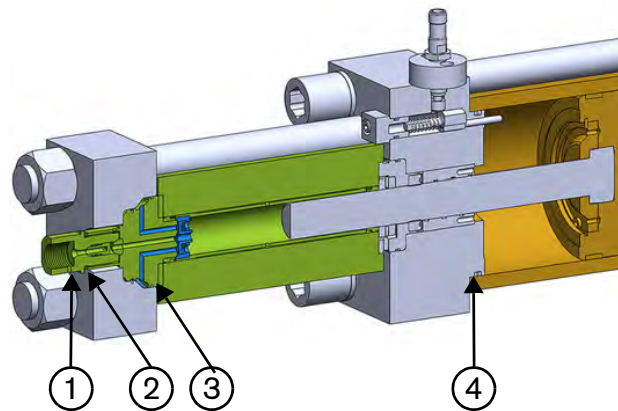

1 Output adapter weep hole

2 High-pressure seat weep hole

3 Static seal leak point

4 Dynamic seal housing weep hole

Water leak from	Possible cause
Output adapter weep hole	<ul style="list-style-type: none"> ▪ A fitting on the high-pressure water tubing is not tight enough. ▪ The tubing end is cracked or damaged. ▪ The output adapter has failed.
High-pressure seat weep hole	<ul style="list-style-type: none"> ▪ The output adapter is loose. ▪ The high-pressure poppet seat has failed. ▪ The seat face of the check valve is cracked. ▪ The check valve O-ring closest to the output adapter has failed.
Static seal leak point	<ul style="list-style-type: none"> ▪ A high-pressure seal has failed. ▪ The check valve O-ring closest to the high-pressure seal has failed.
Dynamic seal housing weep hole	A high-pressure seal has failed.

7 – Troubleshooting

Hydraulic fluid leak from	Possible cause
Dynamic seal housing weep hole	<ul style="list-style-type: none">▪ The rod seal has failed.▪ The O-ring or O-ring backup on the seal housing has failed.
Anywhere on the intensifier	An O-ring has failed.

A leaking high-pressure seal in the intensifier can force water past the rod seal and into the hydraulic fluid. Hydraulic fluid contaminated with water has a milky appearance. Contaminated hydraulic fluid can damage the hydraulic pump.

 Water can only enter the hydraulic system if the weep holes on the dynamic seal backup and the seal housing are blocked. Make sure that the weep holes are free of debris while doing maintenance on the intensifier.

Replace the hydraulic fluid and examine all of the parts, including the inside of the hydraulic fluid tank, the hydraulic hoses, and seals. Refer to page 94 for instructions. It could be necessary to drain and flush out other areas such as the shift valve, hydraulic manifolds, and the hydraulic pump.

Short seal life

If the high-pressure water seals have a short life, take these actions.

- Make sure that the mating surfaces are smooth and free of debris.
- Repair or replace the high-pressure cylinder and plunger.
- Make sure that the water quality is within satisfactory ranges. Refer to the Water quality section, which begins on page 181.
- Check for cracks at the ends of the high-pressure cylinder.
- Replace the high-pressure water seals and hoops.
- Replace the high-pressure cylinder.

If the high-pressure seal backups have a short life, make sure that the plunger bearing is not worn.

Hydraulic fluid

Low pressure

The most common causes of low hydraulic fluid are a leak from a fitting or a hose in the hydraulic system and loss of hydraulic fluid during routine maintenance. A float switch in the hydraulic fluid tank triggers an alarm when the hydraulic fluid level is too low.

Symbol	Fault/warning	Stack light	Result
	Low hydraulic fluid	Red	The intensifier turns off. The pump turns off.



If the hydraulic fluid pressure is low, take these actions.

- Make sure that the cut pressure is set correctly. Refer to page 55 for instructions.
- Make sure that the pump is not in pierce-pressure mode.
- Make sure that the pressure in the hydraulic pump and pressure compensator is increasing.
- Make sure that the relief valve on the pump manifold has not failed.

High temperature

The normal operating temperature of the hydraulic fluid is 37.7°C to 43.3°C (100°F to 110°F). High altitude and high ambient temperatures can have an effect on the temperature of hydraulic fluid. Fluid that is too cool becomes thick and causes increased friction and poor lubrication. Fluid that is too warm becomes thin, which accelerates wear on the parts, increases the formation of sludge, degrades the fluid, and decreases lubrication and protective qualities.

A sensor in the hydraulic fluid tank monitors the hydraulic fluid temperature with 3 switches. One switch closes at 45.0°C (113°F), 1 switch opens at 55.0°C (131°F), and 1 switch opens at 65.0°C (149°F).

Symbol	Fault/warning	Stack light	Result
	The hydraulic fluid temperature is equal to or higher than 55.0°C (131°F)	Amber	The intensifier continues running. The pump continues running.
	The hydraulic fluid temperature is equal to or higher than 65.0°C (149°F)	Red	The intensifier turns off. The pump runs for 2 minutes. After 2 minutes, the pump turns off.

The 55.0°C (130°F) alarm permits the primary motor and the intensifier to continue running. The 65.0°C (150°F) alarm permits the primary motor to continue running for 2 minutes. If the alarm condition is still present, the primary motor turns off.

An unexpected increase in pump temperature indicates a problem with the cooling system. Check these possible causes.

7 – Troubleshooting

Water-cooled systems

The cooling water temperature is too high.	<ul style="list-style-type: none">▪ Make sure that the cooling water is turned on.▪ Adjust the hydraulic fluid temperature. Refer to page 77 for instructions.
---	---

Air-cooled systems

The ambient temperature is too high.	Consider supplemental cooling.
The fan is not generating enough airflow.	<ul style="list-style-type: none">▪ Check the fan motor breaker.▪ The heat exchanger fins could be dirty or clogged.▪ The thermal overload device on the fan motor starter inside the electrical enclosure has turned off the fan motor.▪ Turn the OL-FAN dial to RESET and then to AUTO.



Do not adjust the setting on the thermal overload unless instructed to do so by a Hypertherm Technical Service Associate.

All systems

The cord for the hydraulic fluid temperature/level sensor is unplugged or damaged.	<ul style="list-style-type: none">▪ Plug in the sensor.▪ Replace the cord.
The temperature sensor is faulty or damaged.	Replace the sensor.

Low water pressure

From the intensifier

It is normal for the pump pressure to fall when the cutting head is turned on. If the pressure falls lower than 276 bar or 27 579 kPa (4,000 psi), take these actions.

- Make sure that the orifice is not defective.
- Make sure that the intensifier does not stroke when it is in cut-pressure mode with the cutting head turned off. If it does stroke, check the bleed-down valve and the high-pressure tubing for leaks.
- If there are no leaks, make sure that the low-pressure and high-pressure poppets are in good condition.
- Examine the check valves. Repair or replace them if necessary.

To the intensifier

A pressure switch downstream from the water filters senses water pressure to the intensifier. A sustained pressure lower than 2.8 bar or 275 kPa (40 psi) causes the pump to turn off. This protects the system from running without enough pressure to the intensifier.

Symbol	Fault/warning	Stack light	Result
	The inlet cutting water pressure is lower than 2.8 bar or 275 kPa (40 psi)	Red	The intensifier turns off. The pump runs in cooling mode.

The most common cause of this alarm is a lack of water to the pump. If this is suspected to be the cause of the alarm, take these actions.

- Make sure that the utility water to the pump is turned on.
- Make sure that the water filters are not clogged.
- Make sure that the water valve is not plugged.
- Make sure that the cutting water solenoid fuse is not blown.



The fuse holder light comes on when a fuse blows.



Determine the cause of a blown fuse before replacing it. For fuse sizes and locations, refer to the technical drawings. Some spare fuses are included with the controller. All fuses can be purchased from Hypertherm or an electrical supply store.



If a fuse blows because of a damaged solenoid valve, replace the valve.

Motor fault

Symbol	Fault/warning	Stack light	Result
	Primary motor fault	Red	The intensifier turns off. The pump turns off.

A primary motor fault means that there is a problem starting or running the motor. If this is suspected to be the cause of the alarm, take these actions.

- Make sure that an orifice is not broken.
- Make sure that the plumbing is not leaking.
- Check the primary motor for an electrical short and for loose or damaged wiring.

Section 8

Pump specifications

This section includes details about the pump, including this information:

- Power and water specifications and orifice sizes for each pump model
- Physical qualities such as dimensions, weight, and capacity
- Recommended operating conditions
- A description of the utility panel
- A map of water movement through the system
- Information about fasteners and fittings
- Information about lubricants used for in and on this pump

8 – Pump specifications

HyPrecision 15

Dimensions and weights

Width	864 mm (34 in.)	Shipping weight	498 kg (1,908 lb)
Length	1,778 mm (70 in.)	Operating weight	947 kg (2,088 lb)
Height	1,168 mm (46 in.)		

 The shipping weight is for the pump, pallet, and packaging. Exact weights are determined at shipment. Operating weight is for an unpackaged pump with hydraulic fluid.

11 kW, 15 hp	50 Hz	60 Hz	
Voltage	400 V	208 V to 230 V	460 V
Full-load current	23.4 A	42.8 A to 38.8 A	19.2 A
Primary circuit breaker rating	25.0 A	50.0 A	25.0 A

CUTTING WATER IN	Minimum	Maximum
Flow	3.8 L/minute (1 gallons/minute)	—
Pressure	3 bar or 276 kPa (40 psi)	8 bar or 793 kPa (115 psi)
CUTTING WATER OUT	Minimum	Maximum
Flow	—	1.1 L/minute (.3 gallons/minute)
Pressure	552 bar or 55,158 kPa (8,000 psi)	4,137 bar or 413,685 kPa (60,000 psi)
Continuous pressure	—	4,137 bar or 413,685 kPa (60,000 psi)
Cutting water pressure factory setpoint	—	4,137 bar or 413,685 kPa (60,000 psi)
Piercing water pressure factory setpoint	1,379 bar or 137,895 kPa (20,000 psi)	—
COOLING IN and COOLING OUT	Minimum	Maximum
Flow	11.4 L/minute (3 gallons/minute)	—
Pressure	2.8 bar or 276 kPa (40 psi)	8 bar or 793 kPa (115 psi)

This model supports these orifice sizes.

Number of orifices	
1	0.18 mm (.007 in.)
2	0.13 mm (.005 in.)
3	0.25 mm (.010 in.)

HyPrecision 30

Dimensions and weights

Width	864 mm (34 in.)	Shipping weight	938 kg (2068 lb)
Length	1,778 mm (70 in.)	Operating weight	1,020 kg (2248 lb)
Height	1,168 mm (46 in.)		

 The shipping weight is for the pump, pallet, and packaging. Exact weights are determined at shipment. Operating weight is for an unpackaged pump with hydraulic fluid.

22 kW, 30 hp	50 Hz	60 Hz	
Voltage	400 V	208 V to 230 V	460 V
Full-load current	43.7 A	86.8 A to 79.0 A	43.4 A
Primary circuit breaker rating	50.0 A	100.0 A	50.0 A

CUTTING WATER IN	Minimum	Maximum
Flow	4.6 L/minute (1.2 gallons/minute)	—
Pressure	2.8 bar or 276 kPa (40 psi)	8 bar or 793 kPa (115 psi)
CUTTING WATER OUT	Minimum	Maximum
Flow	—	2.3 L/minute (.6 gallons/minute)
Pressure	552 bar or 5,558 kPa (8,000 psi)	4,137 bar or 413,685 kPa (60,000 psi)
Continuous pressure	—	4,137 bar or 413,685 kPa (60,000 psi)
Cutting water pressure factory setpoint	—	4,137 bar or 413,685 kPa (60,000 psi)
Piercing water pressure factory setpoint	1,379 bar or 137,895 kPa (20,000 psi)	—
COOLING IN and COOLING OUT	Minimum	Maximum
Flow	11.4 L/minute (3 gallons/minute)	—
Pressure	2.8 bar or 276 kPa (40 psi)	8 bar or 793 kPa (115 psi)

This model supports these orifice sizes.

Number of orifices			
1	0.28 mm (.011 in.)	4	0.13 mm (.005 in.)
2	0.18 mm (.007 in.)	5	0.10 mm (.004 in.)
3	0.15 mm (.006 in.)	6	0.10 mm (.004 in.)

HyPrecision 50

Dimensions and weights

Width	864 mm (34 in.)	Shipping weight	1,040 kg (2292 lb)
Length	1,778 mm (70 in.)	Operating weight	1,121 kg (2472 lb)
Height	1,168 mm (46 in.)		

 The shipping weight is for the pump, pallet, and packaging. Exact weights are determined at shipment. Operating weight is for an unpackaged pump with hydraulic fluid.

37 kW, 50 hp	50 Hz	60 Hz	
Voltage	400 V	208 V to 230 V	460 V
Full load current	72.3 A	136.7 A to 123.7 A	61.8 A
Primary circuit breaker rating	100.0 A	175.0 A	100.0 A

CUTTING WATER IN	Minimum	Maximum
Flow	7.6 L/minute (2 gallons/minute)	—
Pressure	2.8 bar or 276 kPa (40 psi)	8 bar or 793 kPa (115 psi)
CUTTING WATER OUT	Minimum	Maximum
Flow	—	3.8 L/minute (1 gallons/minute)
Pressure	552 bar or 55,158 kPa (8,000 psi)	4,137 bar or 413,685 kPa (60,000 psi)
Continuous pressure	—	4,137 bar or 413,685 kPa (60,000 psi)
Cutting water pressure factory setpoint	—	4,137 bar or 413,685 kPa (60,000 psi)
Piercing water pressure factory setpoint	1,379 bar or 137,895 kPa (20,000 psi)	—
COOLING IN and COOLING OUT	Minimum	Maximum
Flow	11.4 L/minute (3 gallons/minute)	—
Pressure	2.8 bar or 276 kPa (40 psi)	8 bar or 793 kPa (115 psi)

This model supports these orifice sizes.

Number of orifices			
1	0.36 mm (.014 in.)	4	0.18 mm (.007 in.)
2	0.25 mm (.010 in.)	5	0.15 mm (.006 in.)
3	0.20 mm (.008 in.)	6	0.13 mm (.005 in.)

All models

Hydraulic fluid

Type	<ul style="list-style-type: none"> ▪ ISO viscosity grade (VG) 32 or 46 antiwear mineral oil ▪ synthetic hydraulic fluid
Tank capacity	151 L (40 gallons)
Maximum temperature	54.4°C (130°F)
Maximum pressure Hydraulic pump pressure limit set at the factory	217 bar or 21,718 kPa (3,150 psi)

Operating conditions

	Minimum	Maximum
Relative humidity	—	95%
Storage temperature Water not drained	1.7°C (35°F)	—
Ambient operating temperature	4.4°C (40°F)	35.0°C (95°F)

 If the cooling and cutting water temperature is higher than 23.9°C (75°F), cool the water before use. Water that is too warm is inefficient for cooling and can reduce high-pressure seal life.

Cooling requirements

HyPrecision pump model	kW (minimum)	Refrigeration tons (minimum tons)	Heat removal requirement (minimum Btu/hour)
15	3	0.83	10,000
30	6	1.67	20,000
50 and 50S	9	2.67	32,000
75S	14	4.00	48,000
100D	19	5.33	64,000
150D	28	8.00	96,000

 Refrigeration tons is the heat transfer required at 0°C (32°F) to make 1 short ton (2,000 lb) of ice in 24 hours.
4 kW = one refrigeration ton = 12,000 Btu/hour



Do not use glycol in a chiller at a concentration of more than 25%.

 Using a chiller with a water-glycol solution reduces the efficiency of the heat exchanger.

8 – Pump specifications

Utility fittings

Utility fittings are found on the rear of the pump.

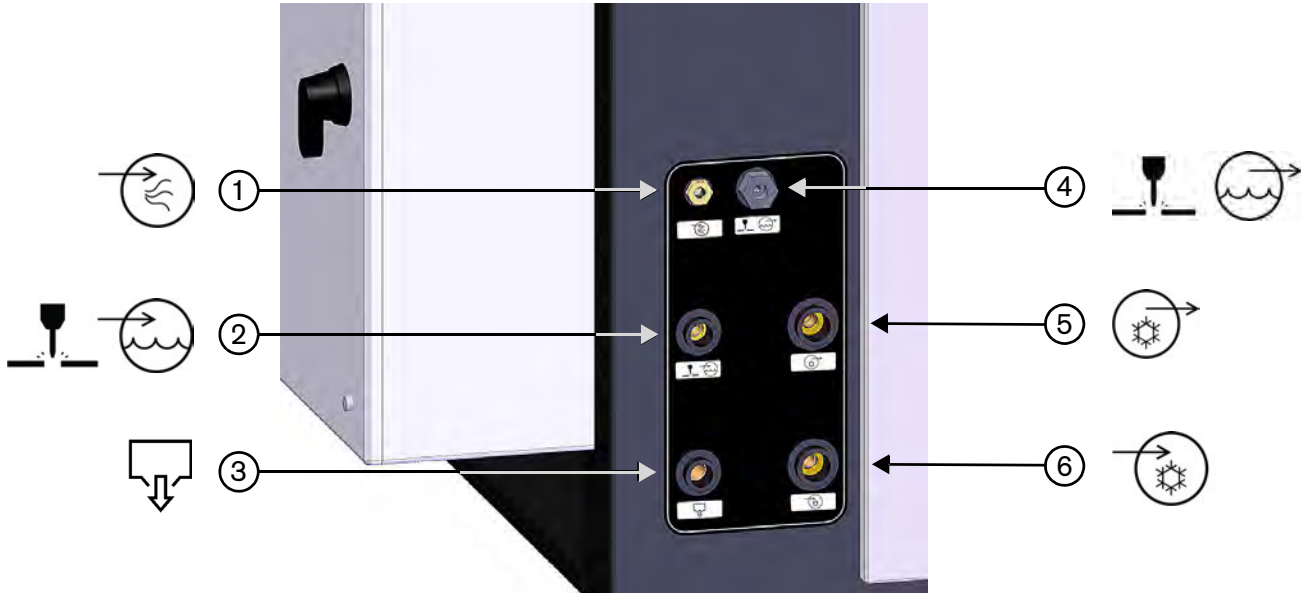

- | | |
|--------------------|---------------------|
| 1 AIR IN | 4 CUTTING WATER OUT |
| 2 CUTTING WATER IN | 5 COOLING OUT |
| 3 WASTEWATER OUT | 6 COOLING IN |

This diagram describes the flow of water through the pump system.

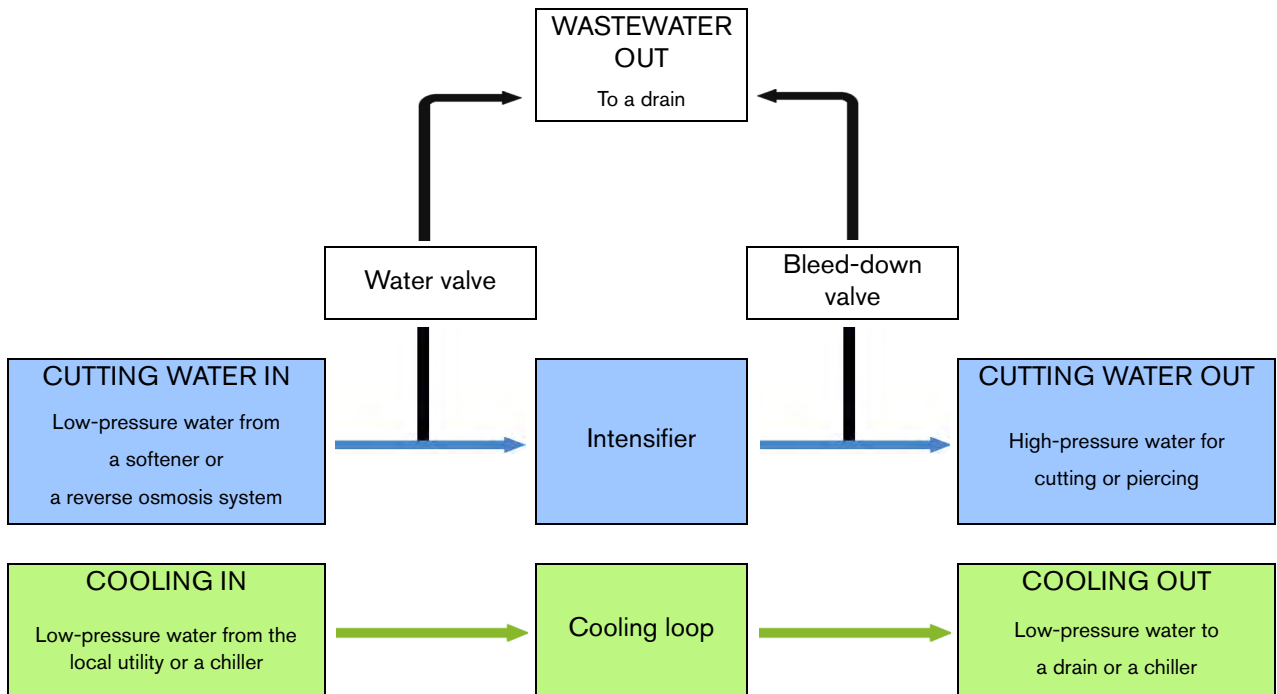

Torque values

Fasteners

When installing more than 1 fastener on a part, tighten each fastener in 45° increments using a repeating sequential cross pattern until the recommended torque is reached.

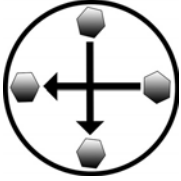

Because of high forces inside the intensifier, all bolts and cap screws that fasten load-carrying parts are grade 8. Fasteners that are exposed to cyclic loading also use lock washers. Torque load-carrying fasteners to the specifications in these tables unless otherwise noted.

Torque values can vary depending on thread condition. A sufficient seal can be made at values much lower than the maximum values shown in the table. Use only enough torque to make a sufficient seal.

This chart applies to all fasteners used on hydraulic and high-pressure water parts.

Special fasteners

These torque values are for bolts that are coated in white lithium grease antiseize bolt lubricant.

	Wrench size	Torque	
		N·m	lbf·ft
High-pressure end cap nut	1-1/2 in.	373	275
Intensifier cap screw	7/8 in.	373	275
Hydraulic fluid tank access cover	15/16 in.	27	20
Proximity switch cap screw	3/16-in. hex	11	8
Indicator pin cap screw	5/32-in. hex	5	4

8 – Pump specifications

SAE J518 flange bolts

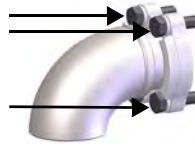

1/16-in. dash size	Bolt size	Code 61 Grade 8		Code 62 Grade 8	
		N-m	lbf-ft	N-m	lbf-ft
-08	5/16-28 in.	33	24	33	24
-12	3/8-16 in.	60	44	60	44
-16	3/8-16 in.	60	44	92	68
-20	7/16-14 in.	92	68	150	111
-24	1/2-13 in.	150	111	296	218

 These torque values are for bolts that are coated in white lithium grease antiseize bolt lubricant.

Lubricate the O-rings with hydraulic fluid or O-ring lubricant before assembly. To make a good seal, the seal face must be parallel to the mating surface and the bolt tension must be even. Align the flange face to the mating surface.

Fittings

	Do not use lubricants on low-pressure water fittings.
---	---

These charts apply to all hydraulic and high-pressure water fittings.

Special fittings

Use a high-pressure antiseize lubricant such as Blue Goop or AccuGoop on high-pressure water fittings.

	Wrench size	Torque	
		N-m	lbf-ft
Output adapter	1 in.	41 to 47	30 to 35

High-pressure water fittings (gland nuts)

Fitting size	Wrench size	Torque	
		N-m	lbf-ft
1/4 in.	5/8 in.	20 to 34	15 to 25
3/8 in.	13/16 in.	47 to 61	35 to 45
9/16 in.	1-3/16 in.	81 to 102	60 to 75

Use these values when no other torque is identified. Use a high-pressure antiseize lubricant such as Blue Goop or AccuGoop on high-pressure water fittings.

 Other torque specifications could be included on the drawings.

8 – Pump specifications

Hydraulic fittings

NPT



Size	Standard maximum		Maximum torque value when using thread sealant (75% of standard maximum)		Maximum torque value when using a male tapered pipe thread with a female straight or parallel pipe thread (50% of standard maximum)	
	N-m	lbf-ft	N-m	lbf-ft	N-m	lbf-ft
1/4 in.	34	25	26	19	18	13
3/8 in.	47	35	35	26	24	18
1/2 in.	61	45	46	34	31	23
3/4 in.	75	55	56	41	38	28
1 in.	88	65	66	49	45	33
1-1/4 in.	108	80	81	60	54	40
1-1/2 in.	129	95	96	71	65	48

This table shows maximum values. The torque necessary to make a sufficient seal depends on the condition of the pipe threads and could be much lower than the maximum.



For hydraulic fittings, lubricate the O-rings with hydraulic fluid or O-ring lubricant before assembly.



Hypertherm recommends using thread sealant on all NPT hydraulic fittings. When using thread sealant on a male tapered pipe thread with a female straight or parallel pipe thread, the maximum value is 50% of the standard maximum.

Steel JIC 37°



Brass JIC 37°



SAE O-ring boss



1/16-in. dash size	Minimum		Maximum		Minimum		Maximum		Minimum		Maximum	
	N-m	lbf-ft	N-m	lbf-ft	N-m	lbf-ft	N-m	lbf-ft	N-m	lbf-ft	N-m	lbf-ft
-04	14	10	15	11	7	5	8	6	14	10	16	12
-06	23	17	26	19	16	12	20	15	24	18	27	20
-08	46	34	52	38	27	20	33	24	43	32	47	35
-10	68	50	76	56	46	34	54	40	62	46	68	50
-12	95	70	106	78	72	53	81	60	88	65	95	70
-16	127	94	141	104	100	74	111	82	125	92	136	100
-20	168	124	187	138	102	75	113	83	169	125	190	140
-24	212	156	235	173	107	79	118	87	203	150	224	165



Sizes -08 and smaller are less tolerant of overtorquing. Overtorquing reduces the clamping force, which causes an insufficient seal.













Do not lubricate brass JIC fittings.
Do not use thread sealant on SAE hydraulic fittings.

Lubricate the O-rings with hydraulic fluid or O-ring lubricant before assembly. Lubricate the threads of JIC steel fittings with hydraulic fluid.





Section 9

Installation

Safety

	Refer to the instruction manual. Read and understand all of the safety guidelines in this manual.
 DANGER	To reduce the risk of serious injuries or death, wear approved protection and follow safety recommendations when working with electricity.
 WARNING	A waterjet is a cutting tool. A high-pressure injection injury is a surgical emergency. Seek immediate medical treatment for all high-pressure waterjet injuries. Delayed treatment can lead to serious injuries or death.
 WARNING	Do not touch a hot surface.
 WARNING	Eye, ear, and respiratory protection, safety shoes, and other personal protective equipment are recommended. Failure to wear personal protective equipment can result in injuries or death.
 WARNING	Do not operate the pump without the shaft access cover and all other safety devices correctly installed. Do not remove guards while the pump is operating.
 CAUTION	If a water line, fitting, or valve might be frozen, do not operate the pump. Thaw the system until water moves freely through the entire water circuit.
 CAUTION	This pump is capable of generating water pressure of up to 4,137 bar or 413,685 kPa (60,000 psi). Only use high-pressure tubing that is rated for this pressure.
 CAUTION	Support all plumbing to prevent bending stress and fatigue from vibration. A disruption or crack in plumbing can cause injuries to people or damage to equipment.
	High-pressure water can cause eye injuries. Wear approved eye protection when operating or working near this equipment.

9 – Installation

	<p>This waterjet system might exceed national and local codes for permitted noise levels.</p> <p>When this pump is running, the noise level is 80 dB(A) to 85 dB(A). Noise level is related to factors such as water flow rate, pipe layout, and the acoustical characteristics of the building.</p> <p>Prolonged exposure to noise can cause permanent hearing loss. Wear approved ear protection and control exposure time when operating or working near this equipment.</p>
	<p>High-pressure water can cause severe cuts or lacerations, abrasions, and punctures. Wear approved hand protection when operating or working near this equipment.</p>
	<p>Some materials can produce airborne contaminants or suspended particles when cut. Wear approved respiratory protection.</p>
	<p>Examine and clean the pump regularly. Make repairs immediately.</p>
	<p>Keep the work area clean and free of fluid spills.</p>

Hypertherm products are designed and manufactured with a commitment to continuous quality control and safety. Contact a Hypertherm Technical Service Associate for information and support regarding the installation, operation, maintenance, and repair of this equipment.

Buyer obligations

The buyer is responsible for these obligations:

- Cooperate with Hypertherm and the Hypertherm original equipment manufacturer (OEM) regarding the installation of the equipment.
- Research and comply with all local codes, including requirements for wastewater disposal.
- Install high-pressure tubing.
- Install water-treatment equipment before the pump is installed.
- Make sure that all utilities are available during installation. The site must have sufficient electrical power, air, water, and sewer drain access.
- Make all connections to the pump.

 Hypertherm does not always supply the pump with hydraulic fluid in the tank. It is the buyer's responsibility to fill the tank with hydraulic fluid.



Seller obligations

If Hypertherm Inc. installs the equipment, some or all of these tasks are the responsibility of the Hypertherm technician as defined in the sales agreement.

- Make sure that the buyer understands all buyer obligations.
- Make sure that the site is prepared for installation.
- Make sure that all utility connections have been correctly routed.
- Follow all setup and first-time startup instructions in this manual.
- Supply training for maintenance and repair procedures.
- Follow standard system acceptance tests.

Requirements

Location

 WARNING	Some locations can be hazardous if the atmosphere contains gas, vapors, or dust in explosive quantities. Refer to requirements from the National Electric Code (NEC), the International Electrotechnical Commission (IEC), and the Occupational Safety and Health Administration (OSHA), as well as local codes for detailed information about environmental criteria.
 CAUTION	When work must be done in confined spaces with limited access, the access must not be blocked by ventilation ducts, hoses, pipes, or other equipment.

Put the pump on a flat surface, such as concrete, that is capable of supporting the weight of the pump and thick enough to resist vibration. The feet on the frame can be adjusted to level the pump.

Make sure that there is a minimum clearance of 91 cm (36 inches) on all sides of the pump to permit air movement for efficient cooling and room for maintenance and repair.

Temperature



	Do not install the pump in an environment where the temperature is below freezing. Freezing can cause severe damage to low-pressure and high-pressure water parts.
---	--

Ambient temperature has an effect on cooling. Supplementary cooling is usually necessary for a pump confined to a small, high-temperature space.

 For temperature requirements, refer to the Pump specifications section, which begins on page 165.

9 – Installation

Electrical power

 DANGER	To reduce the risk of serious injuries or death, wear approved protection and follow safety recommendations when working with electricity.
 WARNING	Make sure that a line disconnect switch for incoming electrical power is installed near the pump's power supply to serve as a supply-voltage disconnecting or isolating device.

The motor size determines the full load amperes, the overload settings, and the wire sizes. Refer to the technical drawings for more information.



 The electrical power requirements are on the data plate on the rear of the pump and on the inside of the electrical enclosure door.

Make sure that the primary feed protection device (circuit breaker or fuse) is sized to handle inrush and steady-state current.



Use a motor-start circuit breaker or the equivalent if time-delayed high-inrush fuses are not permitted by local or national codes.

Air

The recommended air pressure is 5 bar or 483 kPa (70 psi).

 CAUTION	Air pressure higher than 6 bar or 552 kPa (80 psi) can cause damage to the bleed-down valve.
	Air should be dried and filtered before it enters the pump.

Water

	Do not use deionized water unless the system has stainless steel water fittings. Using deionized water in standard systems can cause the plumbing parts to fail and causes substantially shorter consumable life.
	Check local codes to determine if a backflow prevention valve is required to separate the pump from the facility's potable water.
	If the cooling and cutting water temperature is higher than 24°C (75°F), cool the water before use. Water that is too warm is inefficient for cooling and can reduce high-pressure seal life.

 For minimum and maximum flow, pressure, and temperature requirements, refer to the Pump specifications section, which begins on page 165.

Water quality

The quality of the water supplied to the intensifier has a direct effect on the life of pump parts. Poor water quality increases operating costs by causing unnecessary wear on pump parts and shortening maintenance intervals.

Before installing the system, have a water quality analysis done. Water quality reports that show pH, silica, and hardness levels are frequently available for no charge from local public utility suppliers.

Total suspended solids (TSS)

Suspended solids refers to small, solid particles that are suspended in water. Filters are used to remove these solids. Hypertherm pumps include water filters that remove TSS from the cutting water.

Total dissolved solids (TDS)

Dissolved solids refers to molecular, ionized, or microgranular particles in solution in water. TDS include hard elements such as iron, calcium, magnesium, and silica, which form deposits on the inside of high-pressure plumbing and can damage check valves, seals, orifices, and other consumables.

Most systems require softened water. Consult a specialist for recommendations when choosing a water treatment system.

 Reverse osmosis systems are available from Hypertherm.

9 – Installation

Test the water quality

 Some TDS meters require calibration before use. For best results, calibrate the meter at 25.0°C (77°F). Refer to the instructions supplied with the TDS meter.

 Utility and well water quality can change over time. Hypertherm recommends regular testing.

Required tools, materials, and parts

- pH tester
- Silica test kit
- Water hardness (calcium carbonate) test kit
- 13897 TDS meter
- Container for water sample

1. Collect a sample of water. Make sure that the water is clear, odorless, and free of biological materials.
2. Test the pH. The ideal pH measurement is between 6.0 and 8.0.
3. Test the silica (SiO₂) content. Silica content must be lower than 0.0015% (15 parts per million [ppm]).
4. Test the water hardness. The result must be equal to or lower than 0.006% (60 ppm).
5. Test the TDS concentration. The ideal range is 0.005% to 0.015% (50 to 150 ppm).
 - A TDS level lower than 0.005% (50 ppm) can harm waterjet parts and requires the use of nonmetallic or stainless steel fittings.



Water at or below 0.005% (50 ppm) can damage stainless steel waterjet parts.

- Treat water with a TDS level higher than 0.015% (150 ppm) with reverse osmosis or consider using deionized water.

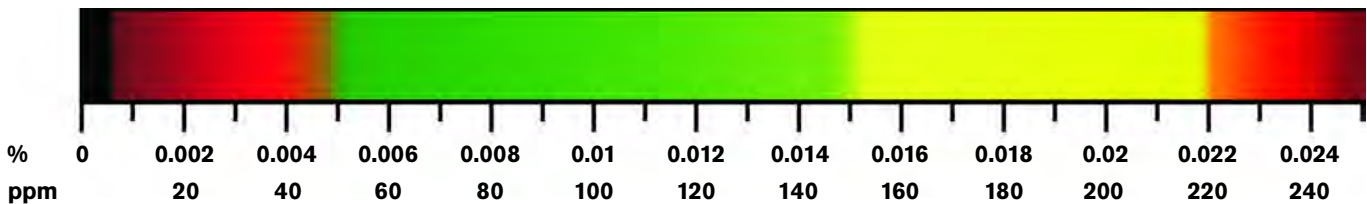

Unacceptable less than 0.005% (50 ppm)	Ideal 0.005% to 0.015% (50 ppm to 150 ppm)	Acceptable 0.015% to 0.022% (150 ppm to 220 ppm)	Unacceptable more than 0.022% (220 ppm)
Use nonmetallic or stainless steel fittings.		Consider using a reverse osmosis system to remove TDS.	Use a reverse osmosis system to remove TDS.

Receive and unpack the pump

Unload the pump



Misuse of lifting equipment could cause the load to become unstable, which can result in property damage, personal injury, or death.

Lifting must be done by a trained operator. Follow all of the relevant work site safety requirements, the safety instructions for the lifting equipment, and the safety information in this manual.

1. Examine the pallet for cracks or damage.
2. Test the hydraulic controls on the lifting equipment before picking up a load.
3. Refer to the operation instructions for the lifting equipment.

Unpack the pump



Boxes and parts are frequently packed inside the pump, or in crates, boxes, and packaging. Look for accessories and spare parts before discarding the packaging.

1. Remove the pump from the shipping pallet. Use the leveling feet to level the pump on a flat surface.
2. Make sure that these items are included and complete.
 - ❑ Basic tool kit (optional)
 - ❑ Basic spare parts kit (optional)
This kit is usually inside the case for the basic tool kit.
 - ❑ The key for the LOCAL/REMOTE key switch
This is usually shipped inside the electrical enclosure.
 - ❑ A copy of the electrical schematic
This is usually shipped inside the electrical enclosure.
3. Make sure that the equipment was not damaged during transportation. If the equipment was damaged during shipment, a claim must be filed with the carrier.
4. Make sure that the delivery and shipping documents match the equipment that was ordered and what was received. Report shortages or damages to the OEM or to Hypertherm Waterjet within 10 days of receipt of the equipment.



For easy reference, write the pump information on the Pump information page at the front of this manual.

Inspect the pump

- Make sure that the equipment was not damaged during transportation. If the equipment was damaged during shipment, a claim must be filed with the carrier.
- Make sure that the delivery and shipping documents match the equipment that was ordered and what was received.
- Report shortages or damages to the OEM or to Hypertherm Waterjet within 10 days of receipt of the equipment.



For easy reference, write the pump information on the Pump information page at the front of this manual.

Install the external heat exchanger

An external heat exchanger is an option for air-cooled pumps.



Make sure that there is a minimum clearance of 91 cm (36 inches) in the front and rear of the heat exchanger to permit enough air flow for efficient cooling.

1. Use the attached mounting bars to secure the heat exchanger to the ground or on an elevated platform.
2. The heat exchanger includes 2 hydraulic hoses that are approximately 9 m (30 feet) long. Connect 1 end of each hose to the top and bottom ports on the heat exchanger.
3. Connect the 4-conductor cable from the external heat exchanger motor to the panel in the electrical enclosure.
 - ❑ The full load amperes, overload settings, and wire sizes are different, depending on the motor size.
 - ❑ For more information, refer to the electrical enclosure schematic.

Push the cable through the cord grip connector in the electrical enclosure. Connect the cable to the motor starter–contactor.

Make the connections for remote operation



Remote operation is optional.



All controls are 24-volt direct current (DC).

These tables describe the remote connections from a user panel or a computer numerical control (CNC) operator console.

Emergency stop

The OEM or the system integrator is responsible for connecting the emergency stop.

The terminals are in series with the emergency stop circuit. The terminals are wired to dry contacts on the emergency stop at the remote control source.

If the pump is configured to run remotely and has a motion system (robot or cutting table), the emergency circuits from the robot or cutting table can be in series with the local emergency stop circuit.

	Wire number	Type of contact
Operation	5024A	Normally closed
Status	5024A	Normally closed
Discrete pressure input	6022, 6022A	Input, maintained, normally open
Remote mode active indicator	6027, 24COM	Output
Remote pump fault indicator	7004, 24COM	Output

Remote pump run indicator	6047, 24COM	Output
Controls on indicator	5024C	Output

Controls on	Wire number	Type of contact
Operation	6027, 5024A	Momentary, normally open
Status	6027, 5024A	Momentary, normally open

Pump on	Wire number	Type of contact
Operation	6028	Input, momentary, normally open
Status	6028	Input, momentary, normally open
Emergency stop	5024A	Normally closed

Pump off	Wire number	Type of contact
Operation	6029	Input, momentary, normally closed
Status	6029	Input, momentary, normally closed

Cooling mode	Wire number	Type of contact
Emergency stop	6030	Input, momentary or maintained, normally open









Make the connections to the utility panel

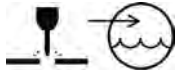

 CAUTION	<p>Do not couple the WASTEWATER OUT and the COOLING OUT lines. Coupling these lines can cause cooling water to back up into the system, which can cause damage to the bleed-down valve and the intensifier parts.</p>
---	---

 **Required tools, materials, and parts**

- 13/16-inch wrench
- 1-1/2-inch wrench
- 5/8-inch wrench
- 1/4-inch NPT male connector
- Two 3/4-inch NPT male connectors
- Two -16 JIC female connectors (for an air-cooled pump)
- Two 1-inch NPT male connectors (for a water-cooled pump)

1. Remove the caps and the covers from the fittings on the utility panel.
2. Connect the air and water lines.

 WASTEWATER OUT	<p>3/4-in. NPT male connector</p>	<p>This line carries water from the bleed-down valve and the low-pressure system to the drain.</p> <p> Install the wastewater plumbing so that it is lower than the fitting on the pump to prevent contaminated water from entering the bleed-down valve.</p>
 COOLING IN	<p>Water-cooled pump 1-in. NPT male connector</p>	<p>Connect this line to the water supply or to the chiller supply.</p> <p> Public utility water is usually sufficient. If the public utility water has a high mineral content, prefiltering or softening might be necessary to prevent deposits from clogging the plates or tubes in the heat exchanger.</p>
	<p>Air-cooled pump -16 JIC female connector</p>	<p>Connect this line to the top fitting on the external heat exchanger.</p>
 CUTTING WATER IN	<p>3/4-in. NPT male connector</p>	<p>Connect this line to the cutting water supply.</p> <p> Treat low-pressure cutting water with a water softener or a reverse osmosis system.</p>
 COOLING OUT	<p>Water-cooled pump 1-in. NPT male connector</p>	<p>Connect this line to the drain or to the chiller return.</p>
	<p>Air-cooled pump -16 JIC female connector</p>	<p>Connect this line to the bottom fitting on the external heat exchanger.</p> <p> The connection on the heat exchanger is usually marked INLET.</p>





 <p>AIR IN</p>	<p>1/4-in. NPT male connector</p>	<p>Connect compressed air to this fitting to operate an air-actuated bleed-down valve.</p>
 <p>CUTTING WATER OUT</p>	<p>3/8-in. high-pressure female connector</p>	<p>Connect a high-pressure plumbing line from this fitting to the waterjet cutting table.</p>

3. Set the air pressure between 4 bar and 6 bar or 414 kPa and 552 kPa (60 psi and 80 psi).

Add hydraulic fluid

Some pumps are shipped without hydraulic fluid. Make sure that hydraulic fluid is available during installation and startup. Refer to page 73 for instructions for adding hydraulic fluid.

Connect the electrical power

 WARNING	A line disconnect switch for incoming electrical power must be installed near the pump's power supply to serve as a supply-voltage disconnecting (isolating) device.
 WARNING	The primary incoming electrical power must be installed by a licensed electrician and must be in compliance with all applicable codes.
 CAUTION	The primary feed protection device (circuit breaker or fuse) must be sized to handle inrush and steady-state current. Use a motor-start circuit breaker or the equivalent if time-delay high-inrush fuses are not permitted by local or national codes.
	When connecting electrical power to the pump, it is the buyer's responsibility to investigate and comply with all local codes.
	Use electrical parts that are certified by national or local electrical codes.

 Pumps equipped for certain foreign electrical power can have different connection requirements. For connection information, refer to the electrical schematic.

 Some pump models have a knockout at the bottom of the electrical enclosure for routing electricity into the enclosure.

 Power requirements are found on the data plate on the back of the pump and on the inside of the electrical enclosure door.

1. Connect the electrical supply to the primary circuit breaker. This breaker is identified on the technical drawing and inside the electrical enclosure as MAIN C.B.
2. Attach a ground leg to the grounding lug inside the electrical enclosure. Use this table to find the minimum cross-sectional area of the external copper ground leg.



If the cross-sectional area (S mm ²) of the copper phase conductors supplying the equipment is	The minimum cross-sectional area (S_p mm ²) is
equal to or greater than 16	equal to S
greater than 16 and less than or equal to 35	16
greater than 35	$S/2$

 The leakage current of HyPrecision pumps can be up to 160 mA. To reduce the effects of a high leakage current, connect the pump to a dedicated supply transformer that has separate windings.

3. Connect the incoming electrical power to the panel inside the electrical enclosure. Refer to the electrical enclosure schematic.

 The voltage, frequency, full load amperes, overload settings, and wire sizes differ depending on the pump size.

Do the first startup

 WARNING	Do not leave waterjet cutting equipment turned on and unattended.
 CAUTION	To prevent catastrophic damage to the pump parts, connect the hydraulic lines between the pump and the external heat exchanger before checking the motor direction on an air-cooled pump.

Use this procedure at installation and after maintenance or repairs are done on the intensifier, the high-pressure water system, or the low-pressure water system.

Do a preoperation inspection

 CAUTION	Fittings, filters, or other parts can come loose during shipping. Make sure that all connections are tight before operating this equipment.
---	---



Examine the equipment before starting the pump.

- Look for leaks, damage, or other conditions that can interfere with operation.
- Check the sight gauge on the hydraulic fluid tank. If necessary, add hydraulic fluid.
- Install all covers and close all doors.

Turn on the utilities

1. Turn ON the electrical breaker.
2. Turn ON the water.
3. Check the water lines for leaks.
4. Turn ON the air supply.
5. Make sure that the primary breaker disconnect lever on the electrical enclosure door is in the ON position.
6. Turn ON the electrical power.

Start the pump

 WARNING	This procedure involves exposing a rotating shaft. Do not put an object or a body part near the shaft while it is exposed. Be prepared to press the EMERGENCY STOP pushbutton.
 CAUTION	Make sure that the primary motor rotates in the correct direction before starting the pump. The pump shaft must turn in the direction shown by the motor rotation arrow decal. Reverse rotation of the pump can unscrew the impeller and cause irreversible damage to the hydraulic pump and its parts.
	Do not do the initial startup with a diamond orifice in position. The likelihood of damaging the orifice during the initial startup is very high.

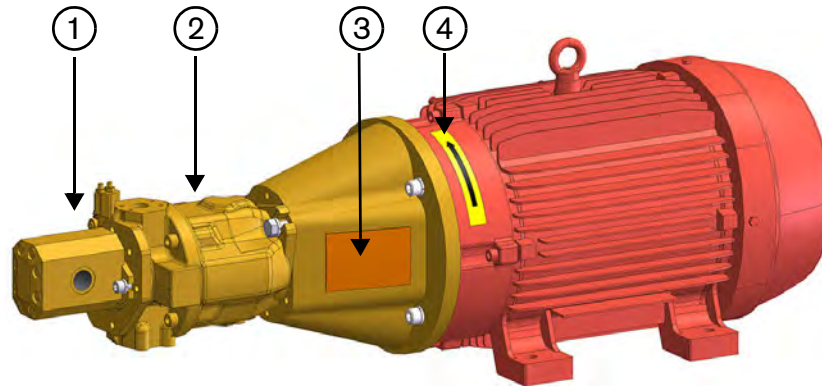

- | | |
|--------------------------|--------------------------------|
| 1 Gear pump | 3 Shaft access cover |
| 2 Primary hydraulic pump | 4 Primary motor rotation arrow |

1. Remove the shaft access cover.
2. Set the pierce pressure to its minimum by turning the control knobs all the way to the left (anticlockwise).
3. Make sure that the LOCAL/REMOTE key switch on the operation panel is in the LOCAL position.
These events occur when the key switch is in the LOCAL position:
 - The pump operates normally.
 - The REMOTE ACTIVE indicator light is off.
 - The operator interface is the primary point of control.
4. Press the CONTROLS ON button to turn on the control circuit inside the pump. The CONTROLS ON button illuminates when pump controls are on.
 The pump can not be turned on until the circuit is on.
5. Turn OFF the cutting head.
6. Press F2 to turn on the pump in cooling mode. The cutting water solenoid opens and the hoses fill with low-pressure water.

7. Make sure that the motor turns in the direction shown by the arrow on the motor mount.

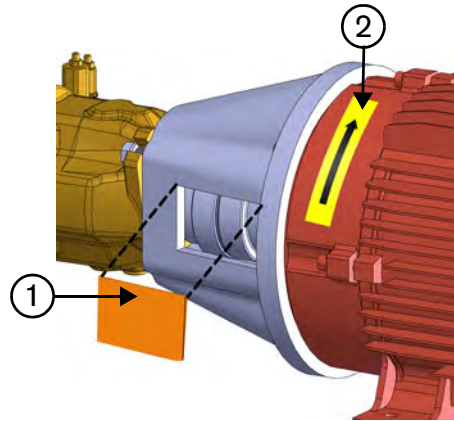

- 1 Shaft access cover
- 2 Motor direction arrow

8. If the pump has an optional external heat exchanger, make sure that the fan motor turns in the direction shown by the arrow.

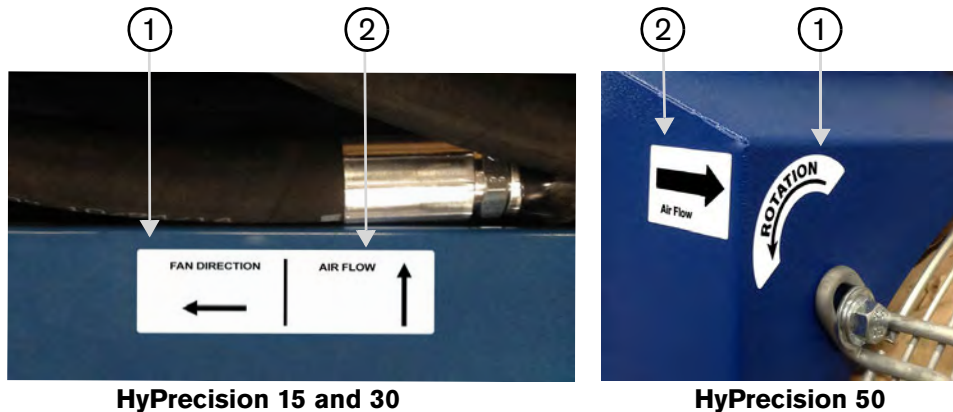

- 1 Fan direction arrow
- 2 Airflow direction arrow



If the pump motor or the fan motor turns in the wrong direction, follow these instructions:

- a. Press the EMERGENCY STOP pushbutton.
- b. Disconnect the electrical power and trade 2 incoming leads on the primary circuit breaker inside the electrical enclosure.

9. Let the pump run for 2 to 3 minutes.
10. Examine for leaks.
11. Press the red buttons on the top of each of the filter housings to release air from the canisters. Hold the buttons down until water comes out around the buttons.
12. Press F1 on the operator interface to start the pump in running mode.
13. Check the high-pressure water, low-pressure water, and hydraulic systems for leaks.

9 – Installation

14. Press 1 on the numeric keypad to change to pierce-pressure mode.

 WARNING	Use a piece of cardboard or other solid material to check for leaks when the pump is on. Do not use hands, cloth, paper, or towels.
 WARNING	Do not attempt to repair a leak with pressure in the system.

15. To clear air from the high-pressure lines, turn ON the cutting head. When water comes out of the cutting head, turn it OFF.

 When the cutting head is turned on, the intensifier strokes.

 The pump is on standby when the cutting head is turned off. Hydraulic pressure remains at the set pressure and the intensifier does not stroke.

16. Slowly turn the control knob to the right (clockwise) to increase the pressure.

Flush the pump and the high-pressure tubing

Follow this procedure after replacing or repairing high-pressure tubing and fittings.

It is common for small pieces of metal and debris to be present in newly installed high-pressure tubing. Flush the system to prevent damage to orifices, on/off valve parts, and other parts of the high-pressure system.

 This procedure identifies 1 method to flush out the high-pressure lines. If this pump was purchased through an OEM, the OEM might have a recommended procedure.

 This procedure can cause damage to the on/off valve sealing parts and orifices. Keep spare kits and orifices available.

1. Press F2 to turn on the pump in cooling mode. The cutting water solenoid opens and the hoses fill with low-pressure water.

 The intensifier does not stroke.

2. Turn the pierce-pressure adjustment knob to the left (anticlockwise) to decrease the pierce pressure.
3. Make sure that the hydraulic pressure is 34 bar or 3,447 kPa (500 psi) or lower. If the pressure is higher than 34.5 bar or 3,447 kPa (500 psi), contact Hypertherm Technical Service for support.
4. Remove the cutting head and the orifice.

5. Press 1 on the numeric keypad to change the pump to cut-pressure mode. (Refer to the Pump running screen on page 53.) The intensifier should stroke until the pump reaches the high-pressure setting and stop stroking.

Two gauge symbols are shown on the screen. If the gauge symbol on the right (cut pressure) is blinking, press 1 on the numeric keypad to switch to the pierce-pressure gauge symbol.

6. Use the CNC control to make a program that turns the valve ON and OFF in 1-second increments. Run the program in a loop for 15 minutes.

If the CNC control is not available, turn the head ON and OFF in 1-second intervals for 15 minutes. This shocks the high-pressure tubing and frees debris in the tubing.

 Debris can cause damage to the on/off valve needle and seat. If this occurs, attempt to complete this procedure by removing debris from the parts rather than replacing the parts right away.

7. Turn the pierce-pressure adjustment knob to the right (clockwise) to increase the pierce pressure to 69 bar or 6,894 kPa (1,000 psi).
8. Run the CNC program in a loop for 15 minutes.
9. Install a ruby orifice in the cutting head. For orifice sizes, refer to the Pump specifications section, which begins on page 165.
10. Run the CNC program in a loop for 15 minutes.
11. Turn the pierce-pressure adjustment knob to the right (clockwise) to increase the pierce pressure to 138 bar or 13,790 kPa (2,000 psi).
12. Run the CNC program in a loop for 15 minutes.
13. Turn the pierce-pressure adjustment knob to the right (clockwise) to increase the pierce pressure to 207 bar or 20,684 kPa (3,000 psi).
14. Run the CNC program in a loop for 15 minutes.
15. Check the on/off valve needle, the seat, the seals, and the orifices for damage. Replace these items if necessary.

Recycling and end of product life

At the end of the life of the product or its parts, recycle or dispose of relevant materials and parts using an environmentally satisfactory method and in accordance with local regulations. If the product contains substances that are harmful to the environment, remove and dispose of them in accordance with current local regulations. This includes liquids such as hydraulic fluid.

Make sure that hazardous substances are disposed of safely and that the correct personal protective equipment is used. The safety specifications must be in accordance with the current local regulations at all times.

